

ON-STREAM SOIL DENSITY MEASURING / ВИЗНАЧЕННЯ ПОТОКОВОЇ ЩІЛЬНОСТІ ҐРУНТУ

Volodymyr KRAVCHUK ¹⁾, Mikhailo IVANIUTA ¹⁾, Viacheslav BRATISHKO ²⁾,
Yuri HUMENIUK ²⁾, Vitaly KURKA ²⁾

¹⁾The Institute of Bioenergy Crops and Sugar Beet National Academy of Agrarian Sciences of Ukraine / Ukraine

²⁾ National University of Life and Environmental Sciences of Ukraine / Ukraine

Tel: +380995044767; E-mail: ur6hdc@ukr.net

DOI: <https://doi.org/10.35633/inmateh-69-64>

Keywords: tillage; soil compaction; soil density; water content of soil; devices for measuring soil density.

ABSTRACT

The article is focused on the determination of the nonlinear relationships between soil compaction, density, and water content. It was found that these properties can be described by the second-order models and used for improving devices for the on-stream soil density measuring. The models for determining the density of loamy soil (at a water content of 20%) in the range from 0.9 to 1.6 g/cm³ with an extremum of 1.35 g/cm³ were improved. A device for the on-stream soil density measuring is proposed. The device operates within the soil compaction range from 0.3 to 1.2 MPa and water content from 10 to 30% at the angle of inclination of the kinematic link γ from 15 to 40 degrees. The obtained results can be used in the adaptation of the proposed device for use in precision agriculture.

РЕЗЮМЕ

В статті наведено результати теоретичних та експериментальних досліджень з визначення нелінійних зв'язків твердості, щільності та вологості ґрунту. Встановлено, що зазначені характеристики можна описати моделями другого порядку та використовувати з метою удосконалення пристроїв потокового визначення щільності ґрунту. Обґрунтовано моделі визначення щільності в діапазоні 0.9-1.6 г/см³ з екстремумом у значеннях 1.35 г/см³ при вологості 20% суглинистого ґрунту. Запропонований пристрій забезпечує отримання зазначених показників щільності ґрунту в межах його твердості 0,3-1,2 МПа, вологості 10-30% при зміні кута нахилу кінематичної ланки γ від 15 до 40 градусів. Результати досліджень можуть бути адаптовані для застосування в сучасних технологіях точного (керованого) землеробства.

INTRODUCTION

The phase composition of the soil is largely affected by soil tillage (Voytyuk et al., 2015, Hudz et al., 2010, Kravchuk, 2018) as it is formed under the action of working elements of machines. Tillage improves plant conditions, increases soil fertility, and protects the ground from water and wind erosion. Tillage helps reach the optimal soil structure in the root soil layer by changing the mechanical characteristics of the soil. The optimal phase composition of soil for most crops is a three-phase disperse system, which consists of a solid (mineral and organic parts), a liquid (water), and a gaseous (air) part (Fig. 1). From the standpoint of solid mechanics, the soil can be defined as a porous body in which the solid particles are crushed and mixed with other components (water and air). Compaction and bulk density are the main physical properties of the soil.

Compaction derives from the potential energy of inter-structural adhesive bonds of the soil. In a broader sense, compaction is an indicator of the deformation of the soil boundary state as a result of the interaction between applied external mechanical forces and resistance reactions of internal stresses (Shvets et al., 2014). In the process of tillage, soil undergoes a complex stress state leading to elastic, plastic deformation, and fracture, resulting in changes in the size and volume of soil particles. These changes relate to the indicator of bulk density (Hudz et al., 2010, Shvets et al., 2014).

Analysis of the literature allowed us to conclude that there is a nonlinear correlation between soil density and compaction (Kushnarev et al., 2010). The relationship between compaction and bulk density received much attention in the works of Kushnarev et al. (2010) and Ajit K. Srivastava et al. (2006). It was also found that soil compaction is largely influenced by the water content and chemical composition of the soil.

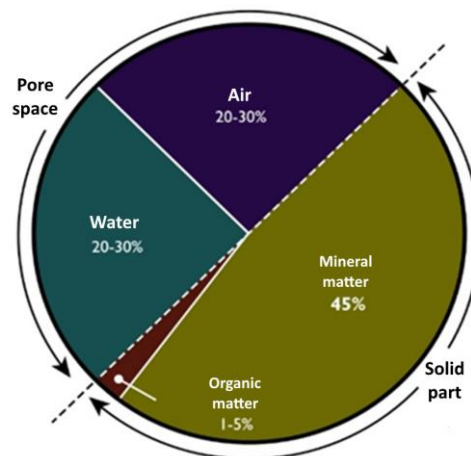

Fig. 1 - Soil phase composition optimal for plants
(Hudz et al., 2010)

There are two known methods of soil compaction measuring – stationary and on-stream (Kushnarev et al., 2010). The first method deploys devices operating by the method of contact selective determination using a compaction meter. In the stationary devices, the measuring plunger moves perpendicular to the soil surface. The on-stream method is based on the selective interaction of the measuring body of the device. In this method, the mechanical resistance of the soil is a function of the resistance response and time $R(t)$, and bulk density is determined with the use of dependencies that include the water content of the soil.

In the context of advanced agrotechnologies, e.g., precision agriculture, searching the limits of relations between soil compaction, density, and water content is necessary for the development of the protocols for the on-stream soil density testing and adaptation of agricultural machines to the specific agrotechnical requirements. The purpose of the research was to study the diapason of nonlinear correlations between soil compaction, bulk density, and water content, which can be used in the improvement of the devices for on-stream soil density measuring.

MATERIALS AND METHODS

Soil density was assessed in accordance with DSTU ISO 11272 (weighting of the dry mass). The water content of soil was determined in accordance with GOST 28268 (oven drying). Compaction was measured with the use of the soil compaction meter SC-900 (USA) by the method of stationary measurements.

Analysis of the response surface (RSM) between independent variables of bulk density X_1 and water content of soil X_2 and the response function with the compaction values Y was performed according to the Box-Wilson method (Box et al., 1951, Kravchuk et al., 2016). The method is based on the correlation relationships between the values of soil density and compaction and the use of empirical coefficients (Table 1). The relationship between soil density and compaction can be described by the second-order polynomial equation (Kushnarev A., et al., 2010) (Fig. 2):

$$\rho = a + bp + cp^2; \tag{1}$$

Where:

- ρ - soil bulk density, [g/cm³];
- p – soil compaction, [N/cm²];
- a, b, c are empirical coefficients.

Table 1

Empirical coefficients for different methods of soil tillage
(Kushnarev et al., 2010)

Method of tillage	<i>a</i>	<i>b</i>	<i>c</i>
Ploughing	698	0.039	0.00038
Deep tollage	657	0.038	0.00062
Subsurface tillage	0.720	0.048	0.0080

Ajit K. Srivastava et al. (2006) found that soil density is largely affected by water content and chemical composition of the soil, as the consistency and structural bonds change due to adhesion, which leads to a change in soil compaction.

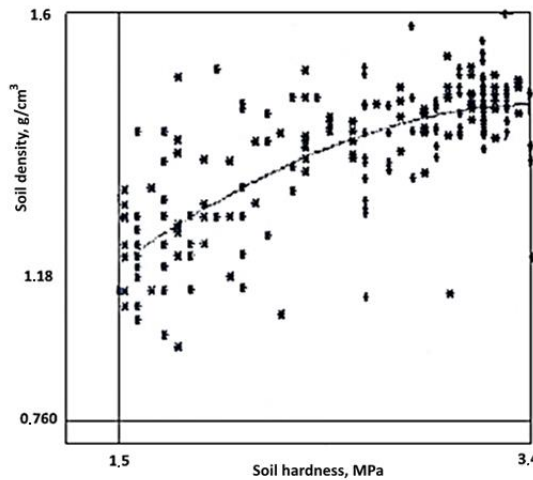

Fig. 2 - Correlation relationships between soil compaction and density in the 0-300 mm layer
(Kushnarev et al., 2010)

We studied the correlations between soil density and compaction using a device for on-stream soil compaction measuring (Kravchuk et al., 2021). The device consists of a frame 1, a kinematic link 2, an angle sensor of the kinematic link 3, an arrow 4, a damper 5, a roller 6, a plunger 7, a holder 8, a cone 9, a position sensor of the measuring roller 10, and a position sensor of the measuring body 11 (Fig. 3).

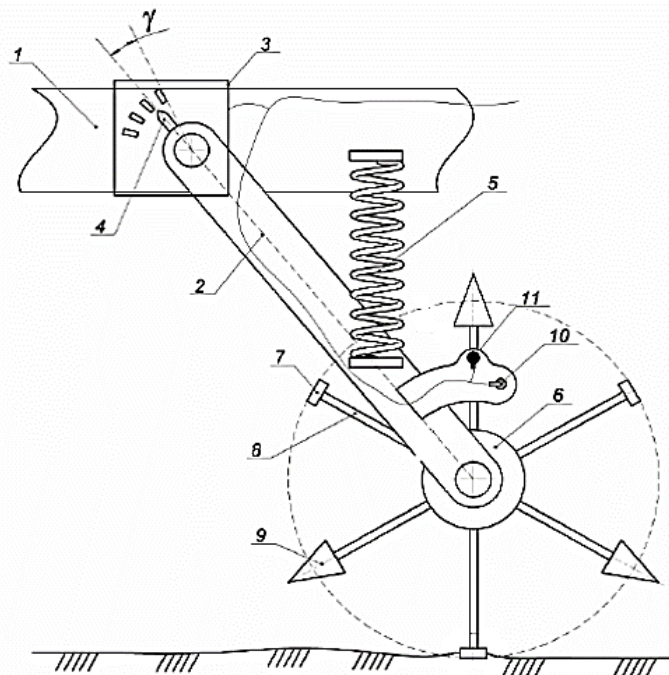

Fig. 3 – Device for soil compaction measuring
(Kravchuk et al., 2021)

The device was tested in a soil channel (8.5 m x 1.2 m x 0.6 m) filled with typical loamy soil of various humidity and density in accordance with the experimental design. Starting from the initial position of the device (indicated by the position sensor of the measuring roller), the kinematic link under the action of a spring (stiffness 18 N/mm) alternatively presses the plunger and the cone to the soil surface. Due to the action of the damper, the plungers and cones alternately immerse into the soil to a certain depth. In the process of immersing the plunger, which depends on the soil compaction and the spring stiffness, the kinematic link is set to a certain angle γ , which is registered by the angle sensor sequentially for each of the measuring bodies.

Soil compaction is calculated based on the values of the angle of inclination of the kinematic link at the moment when the sensor of the measuring body position is in the vertical position.

The relations between the soil properties were studied with the use of the developed device in the full factorial experiment. Three measurements of compaction were taken for each value of soil density and water content. To verify the adequacy of the correlation models, Fisher's approach was exploited, which is based on the exploitation of either a null or alternative hypothesis to the results of experimental studies. Verification of the hypothesis was carried out based on the assessment of the level of significance p in Fisher's test. As a null hypothesis, it is assumed that soil density and water content have no correlations with compaction.

A full two-factor experiment 2^k ($k = 2$) was carried out according to *Oliveira et al., (2019)* and *Borovikov (2013)*. The analysis of variance involved the compilation of a scale of values and factors (Fig. 4) and a matrix with obtained results (Table 3). The studied characteristic was the position angle γ of the kinematic link determined by the sensor, which varied depending on the soil compaction.

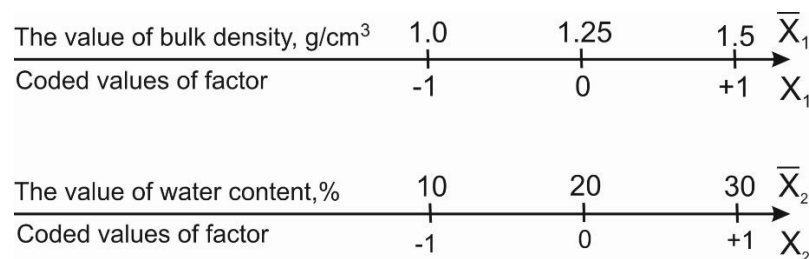

Fig. 4 – Scale of levels and values of the experimental factors

The null hypothesis was adopted regarding the correlations between the factors of soil density and water content with the compaction function, which are related to each other as random variables. To reject the null hypothesis, an additional test was performed (line 10 in Table 2) with the analysis of variance. Statistical data processing was carried out by the variance analysis methods as described by *Borovikov (2013)* using the software Statistica, with replications of ANOVA based on the table of empirical data.

Table 2

Experiment planning matrix 2^2 and data							
Experiment number	X_1	X_2	\bar{X}_1 , (g/cm ³)	\bar{X}_2 , (%)	Y	P , (MPa)	γ , (°)
1	-1	-1	1.0	10	y_1	0.30	35
2	0	-1	1.25	10	y_2	0.35	34
3	+1	-1	1.5	10	y_3	0.38	34
4	-1	0	1.0	20	y_4	0.90	23
5	0	0	1.25	20	y_5	0.95	22
6	+1	0	1.5	20	y_6	1.20	17
7	-1	+1	1.0	30	y_7	0.40	33
8	0	+1	1.25	30	y_8	0.50	31
9	+1	+1	1.5	30	y_9	0.55	30
10	+1	+1	1.5	30	y_{10}	0.58	29

RESULTS

The results of the analysis of variance are given in Tables 3 and 4. The number of bulk density gradations $a = 3$; the number of water content gradations $b = 3$; the number of the experiment replication $r = 1$; the total number of observations $n = 10$; the total number of degrees of freedom $\nu = 9$; the type of approximation – the least-squares method (LSM). The coefficient of determination $R^2=0.74$. SS is the total sum of the squares of deviations; cc is the degree of freedom; MS is the variance; F is the Fisher criterion; L is the difference between the values of the responses at the largest and smallest values of the factors; Q is the quadratic nonlinear effect.

Table 3

Results of the variance analysis

FACTOR	SS	ss	MS	F	p
Bulk density, g/cm ³ (1L)	0.25	1	0.25	3.04	0.16
Bulk density, g/cm ³ (Q)	0.26	1	0.26	3.25	0.15
Water content, % (2L)	0.34	1	0.34	4.18	0.11
Water content, % (Q)	0.02	1	0.02	0.22	0.66
1L to 2L (interaction)	0.00	1	0.00	0.01	0.92
Error	0.32	4	0.08		
Total SS	1.24	9			

From Table 3, it can be concluded that in the first approximation, the obtained p values of the significance level of the Fisher test of all cases of compaction exceed 0.05; therefore, the null hypothesis cannot be rejected. However, to clarify the correlations, the null hypothesis must be replaced with an alternative one. From a statistical point of view, this indicates the presence of a nonlinear correlation between bulk density, water content, and compaction due to the adhesive bonds between structural aggregates of soil.

The results of the additional testing nonlinearity of the correlations between compaction, density, and water content of soil are shown in Table 4.

Table 4

Results of the additional testing nonlinearity of the correlation

Factor	SS	ss	MS	F	p
Bulk density, g/cm ³ (1L)	0.25	1	0.25	197.13	0.045
Bulk density, g/cm ³ (Q)	0.26	1	0.26	210.30	0.044
Water content, % (2L)	0.34	1	0.34	271.08	0.039
Water content, % (Q)	0.02	1	0.02	14:30	0.165
1L to 2L (interaction)	0.00	1	0.00	0.79	537
Loss of coherence	0.32	3	0.11	86.05	0.079
Error	0.00	1	0.00		
Total SS	1.24	9			

The results of the additional test showed that p -values >0.05 were obtained only for the quadratic nonlinear effect of water content, which confirmed the adequacy of the second-order model. Non-linear relationships between water content and soil compaction are described by the response surface (Figs. 5, 6), contour plots of the region of maximum compaction values (Figs. 7, 8), and equations 2, 3.

From Figs. 5.6 it follows that a 10% decrease in water content leads to a 0.35 MPa decrease in soil compaction. This can be explained by the increasing fragility of loamy soil due to a decrease in the adhesion of the structural bonds, which was confirmed by previous research (Terfaya *et al.*, 2018; Cheng *et al.*, 2021).

We obtained the maximum value for the internal adhesive bonds of the loamy soil structure. The total soil compaction was 1.1 MPa at a bulk density of 1.35 g/cm³ and water content of 20%. With an increase in water content to 30%, a 0.55 MPa decrease in compaction was observed, which can be explained by a decrease in adhesive bonds due to the substitution of inter-structural bonds with capillary ones. The substitution leads to a decrease in the force of internal friction when shear stresses are applied, as confirmed by Cheng *et al.* (2021) and Nawaz *et al.* (2013).

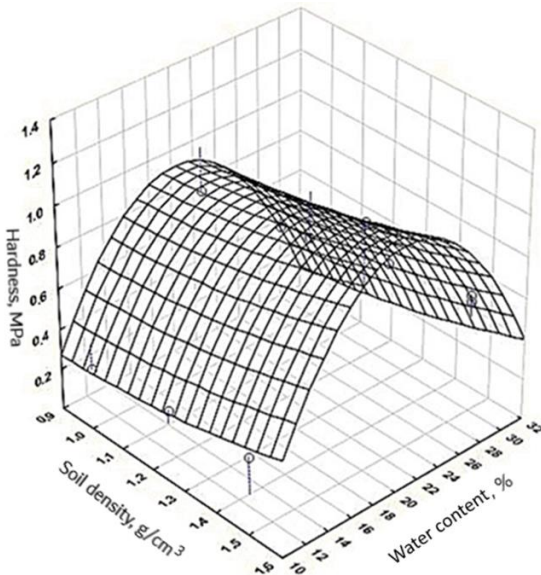

Fig. 5 – Diagram of the response surface of correlations between soil compaction, bulk density, and water content

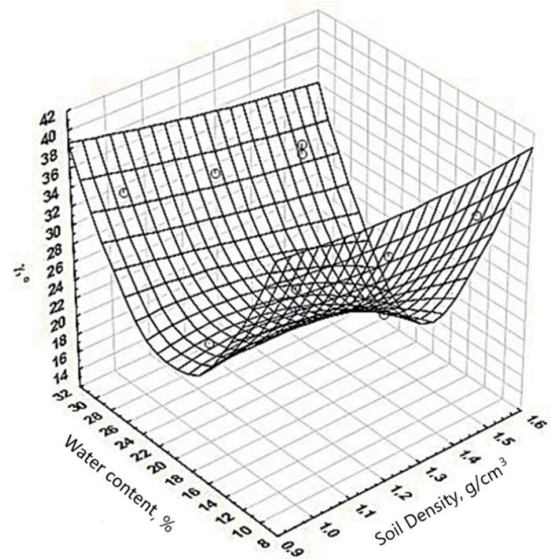

Fig. 6 – Diagram of the response surface of correlations between the angle γ, soil density, and water content

The response surface equation for compaction is the following:

$$Z = - 1.33 - 0.58x - 0.24y + 0.32x^2 + 0.006xy + 0.006y^2 + 0 \tag{2}$$

The response surface equation for the kinematic link position sensor is the following:

$$Z = 67.37 + 10.91x - 4.76y - 5.42 x^2 - 0.2xy + 0.12y^2 + 0 \tag{3}$$

Contour graphs (Fig. 7–8) made it possible to set the range of values of the maximum soil compaction in more detail. The maximum compaction (1 MPa) was observed in the bulk density diapason from 1.5 to 1.6 g/cm³ and water content diapason from 1 to 23% at the determined values of the angle of the kinematic link from 18 to 22 degrees.

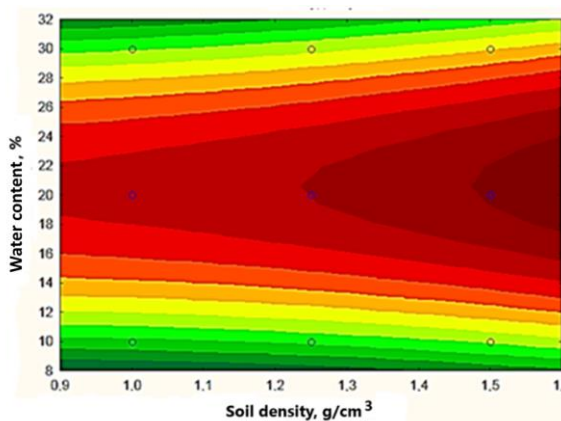

Fig. 7 – Contour graph of soil compaction P, bulk density MPa, and water content relations

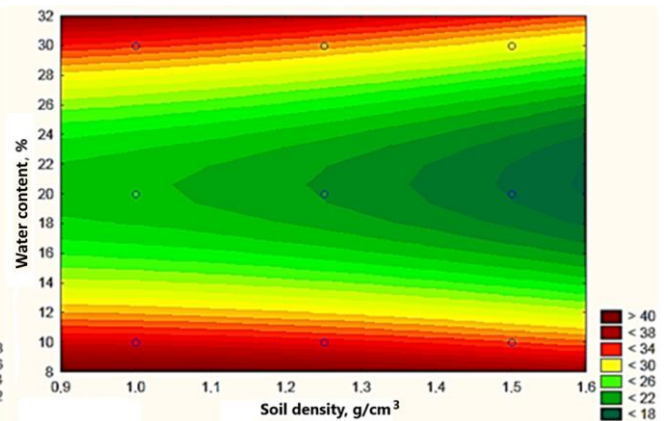

Fig. 8 – Contour graph of angle γ, bulk density, and water content relations

To sum up, the study revealed, that soil, as a porous natural body, has a bearing capacity to support plant life. In the process of tillage, soil’s physical and mechanical properties change depending on the water content, which is consistent with the results of *Khishvand et al. (2017)* and *Panigrahi Goyal (2021)*.

In modern farming systems, major agrophysical properties of soil should be taken into account to reach efficient use of agricultural machines for soil tillage.

CONCLUSIONS

The method of the on-stream soil density measuring during the tillage operations will be promising under the condition that nonlinear models of correlations between soil compaction and water content are taken into account. The second-order models may be used for the on-stream measuring of soil bulk density in the range from 0.9 to 1.6 g/cm³ with a maximum value of 1.35 g/cm³ and water content of 20%. The proposed device is promising for use in precision agriculture. It provides measuring soil density values within the soil compaction range between 0.3 and 1.2 MPa at a water content of 10–30% and a change in the angle of inclination of the kinematic link γ from 15 to 40 degrees.

REFERENCES

- [1] Ajit K. Srivastava, Carroll E. Goering, Roger P. Rohrbach, Dennis R. Buckmaster (2006). *Engineering Principles of Agricultural Machines*, 2nd edition, / American Society of Agricultural and Biological Engineers ASABE, Niles Road, St. Joseph, MI 49085-9659 USA. ISBN 1-892769-50-6. 559 p.
- [2] Borovikov V.P. (2013). *A popular introduction to modern data analysis in the system STATISTICA*. Moscow: Hot line-telecom. ISBN 978-5-9912-0326-5. 288 p.
- [3] Box, G.E.P. and Wilson, K.B. (1951). On the Experimental Attainment of Optimum Conditions. *Journal of the Royal Statistical Society Series B*, 13, 1-45. <https://doi.org/10.1111/j.2517-6161.1951.tb00067.x>
- [4] Cheng, J.; Zheng, K.; Xia, J.; Liu, G.; Jiang, L.; Li, D. (2021), Analysis of Adhesion between Wet Clay Soil and Rotary Tillage Part in Paddy Field Based on Discrete Element Method. *Processes*, Vol.9, p.845. <https://doi.org/10.3390/pr9050845>.
- [5] DSTU ISO 11272 (2001). Soil quality. *Determination of bulk density per dry mass*. National standard of Ukraine. Derzhspozhivstandart. Kyiv.
- [6] GOST 28268 (1989). *Methods for determining moisture, maximum hygroscopic moisture, and moisture of stable wilting of plants*. Standartinform. Moscow.
- [7] GOST 12536 (1979). Soils. Methods of laboratory granulometric (grain size) and microaggregate distribution. Standartinform. Moscow.
- [8] Hudz' V. P., Primak I.D., Budyonny Yu, V., Tanchik S. P. (2010). *Farming: textbook /Kyiv, Center of educational literature*. ISBN 978-611-01-0064-9. 464 p.
- [9] Khishvand M., Nazem M., Sloan SW. Carter JP. (2017). Application of the third medium method for frictionless contact problems in geomechanics, *Computers and Geotechnics*, Vol.85:117–125,
- [10] Kravchuk V.I., Ivaniuta M.V. Shustik L.P. (2021). *Device for operative determination of physical and mechanical properties of soil. Ukraine*, Pat No 147335
- [11] Kravchuk V.I., (2018). *Research and experimental investigation of agricultural machinery and technologies: development and diversification / Doslidnitske, UkrNDIPVT im. Pogorilogo*, ISBN 978-617-657-042-4. 240 p.
- [12] Kravchuk V.I., Khaylis G.A., Kushnarev A.S., (2016). *Research agricultural machinery: textbook / Doslidnitske, UkrNDIPVT im. Pogorilogo*, ISBN 978-617-657-026-4. 328 p.
- [13] Kushnarev A., Kravchuk V., Kushnarev S., Dyuzhaev V. (2010). Monitoring of soil density in the arable horizon in the system of precision (managed) farming. *Machinery and technology of agro-industrial complex*, V №9 (12). Doslidnyts'ke. ISSN 2306-1391. pp. 12:16
- [14] Nawaz M.F., Bourrié G. & Trolard F. (2013). Soil compaction impact and modelling. A review. *Agron. Sustain.* V. 33, pp. 291–309. <https://doi.org/10.1007/s13593-011-0071-8>.
- [15] Oliveira L.G., de Paiva, A.P., Balestrassi, P.P., Ferreira, J.R., da Costa, S.C. and da Silva Campos, P.H., (2019). Response surface methodology for advanced manufacturing technology optimization: theoretical fundamentals, practical guidelines, and survey literature review”, *International Journal of Advanced Manufacturing Technology*, Vol. 104 Nos. 5-8, pp. 1785-1837.
- [16] Panigrahi B., Goyal M. R. (2021). *Modeling Methods and Practices in Soil and Water Engineering*. Oakville, ON L6L 0A2. Apple Academic Press. 375p.
- [17] Shvets V.B., Boyko I.P., Vynnykov Y.L. Zotsenko M.L., Petrakov O.O., Solodjankin O.V., Shapoval V.G., Shashenko O.M., Bida S.V. (2014). *Soil mechanics. Bases and foundations (abridgement): Textbook / Dnipropetrovsk: «Porogi», 2014. – 231 p.*

- [18] Terfaya N., Berga A., Raous M., Abou-Bekr N. (2018). Contact Model Coupling Friction and Adhesion: Application to Pile/Soil Interface. *International Review of Civil Engineering, Praise, Worthy Prize*, V.9 (1), pp.20. <https://hal.archives-ouvertes.fr/hal-03038978>.
- [19] Voytyuk D.G., Aniskevych L.V., Ishchenko V.V. (2015). *Agricultural machinery: textbook* / Kyiv, Agroeducation, ISBN 978-617-7283-06-4. 679 p.