

NAVIGATION, VALIDATION AND EVALUATION OF FOUR-WHEELED ROBOT FOR GREENHOUSE SPRAYING

/

پیمایش، اعتبارسنجی و ارزیابی ربات چهار چرخ برای سمپاشی گلخانه ای

Hossein Mosalanejad¹⁾, Saeid Minaei²⁾, Alimohammad Borghei³⁾, Behfar Farzaneh⁴⁾ 1

¹⁾ Biosystems Engineering Department, Science and Research Branch, Islamic Azad University, Tehran / Iran

²⁾ Biosystems Engineering Department, TarbiatModares University, Tehran / Iran

³⁾ Biosystems Engineering Department, Science and Research Branch, Islamic Azad University, Tehran / Iran

⁴⁾ Department of Agricultural Mechanization Engineering, Islamic Azad University, Eghlid / Iran

*Tel:++982148292466 E-mail: minaee@modares.ac.ir

<https://doi.org/10.35633/inmateh-63-17>

Keywords: Four-wheeled robot; Greenhouse sprayer; Infrared sensor; Ultrasonic sensor; Automatic spraying; Backpack sprayer

ABSTRACT

This study investigates the potential of using a sprayer robot for the greenhouse with bell-pepper plants and compares its performance with the backpack sprayer. The infrared sensors were used to navigate the robot and the ultrasonic sensors were used to distinguish the beginning of each row for automatic spraying. Results showed that the robot's guidance was done well by the infrared sensor. It was capable for spraying plants on both sides of the greenhouse simultaneously with ultrasonic sensor. The sprayer robot had better spray quality and lower solution consumption and spraying time and spray loss than the backpack sprayer.

چکیده

این مطالعه، پتانسیل استفاده از ربات سمپاش برای گلخانه با گیاهان فلفل دلمه ای را بررسی کرده و عملکرد آن را با سمپاش پشتی مقایسه می کند. از حسگرهای فرسرخ برای جهت یابی ربات و از حسگرهای فراصوتی برای تشخیص ابتدای هر ردیف برای سمپاشی اتوماتیک استفاده شده است. نتایج نشان داد که هدایت ربات توسط حسگر فرسرخ به خوبی انجام شده است. این ربات قادر به پاشش همزمان گیاهان در دو طرف گلخانه با حسگر فراصوتی بود. ربات سمپاش نسبت به سمپاش پشتی از کیفیت پاشش بهتر و مصرف محلول، زمان پاشش و اتلاف کمتری برخوردار بود.

INTRODUCTION

Similar to other industries, agriculture has been affected by technological advances (Ko *et al.*, 2014). In the late 20th century, precision agriculture showed increasing attention in the agricultural community (Jafari Malekabadi *et al.*, 2019; Cantelli *et al.*, 2019). Precision agriculture is a new concept that founded based on a series of technological breakthroughs such as GPS, humidity-soil fertility controlling sensors, remote sensing and GIS. It allows higher variability in agricultural products through comprehensive management in the sites of a project (Bengochea-Guevara *et al.*, 2016; Hernandez *et al.*, 2016; Zaman *et al.*, 2019). Deficiencies such as lack of human workforce and replacing automated machines are the motivations for the introduction of robotic systems in agriculture and especially the greenhouse environment (Sanz-Cortiella *et al.*, 2011a, 2011b).

In the modern period, each activity is described with its benefits and efficiency, so greenhouses produce better crops with higher quality (Rincón *et al.*, 2020). The function of a greenhouse is the measurement and control of any factor to achieve its predetermined goals (Roldan *et al.*, 2015; Pahuja *et al.*, 2013; Rodríguez *et al.*, 2015; Zeng *et al.*, 2012). Some of the most fundamental applied sciences in the greenhouses are soil sciences, climate control and combination of other methods such as modern irrigation and nutrition supply techniques, carbon dioxide enrichment and pollination with bees (Roldan *et al.*, 2016; Sharma and Borse, 2016). Studies show that considerable part of total investments in greenhouse units is consumed by the owner and employees (30% of the total cost or even more). Agricultural researchers have an agreement on such a conclusion that higher profit can be achieved by using higher efficiency of work or reducing the number of active workforces (Sánchez-Hermosilla *et al.*, 2013a). The common benefits of such systems are more timeliness, higher accuracy and coordination and lower costs (Sezen, 2003). In the greenhouse, any

¹ Hossein Mosalanejad, Ph. D Student; Saeid Minaei, Professor; Alimohammad Borghei, Professor; Behfar Farzaneh, Assistant Professor

agricultural activity using automated systems needs more effort. Robots (rail and ground robots), sensors (cameras and laser scanners) and actuators (manipulation and grasping systems) are three main systems that are used widely in any modern greenhouse (Sezen, 2003; Younse and Burks, 2007; Sánchez-Hermosilla et al., 2013a; Bengochea-Guevara et al., 2016; Hernandez et al., 2016; Moreno et al., 2016).

Sammons et al. (2005) evaluated inductive sensors for the navigation unit of automatic spraying. They concluded that this sensor was able to track the underground metal pipes. In another study, a fuzzy logic algorithm was used to control functions in the greenhouse mini-robot (Subramanian et al., 2005). The distance and relative location of objects (metallic and non-metallic devices and plants) are measured using proximity sensors. Other types of sensors are useful for such purposes such as capacitive, optical and ultrasound. Harik and Korsaeath (2018) studied a combination of the hector simultaneous localization and mapping and an artificial potential field controller to estimate the robot's position and to perform autonomous navigation inside the greenhouse.

Sánchez-Hermosilla et al. (2013a) investigated the navigation of a robot using laser system. They reported that this system was very reliable, but required several lasers to be mounted in the proximity of corridors. Kalantari et al. (2014) used a robot to spray in greenhouses. They concluded that the uniformity of the spray was better. Mean droplet size at the centreline of the spray was much smaller than dose in the outer side of the full cone spray. The drop size by the nozzle was less than 60 μm which was suitable for insecticide or fungicide applications. Cantelli et al. (2019) used a robot for autonomous spraying in vineyards and greenhouses. Positions were measured integrating the measures of the encoders. The laser scanner and ultrasonic sensor were mounted in the upper-front part of the vehicle. They were used to detect static and dynamic obstacles.

Masoudi et al. (2012) evaluated the ability of ultrasonic sensors to produce guidance signals for greenhouse application robots. Results showed that the accuracy of the sensor was good for distances between 15 and 215 cm and angles between 0 and 30°. Sensors of flat surfaces and round surfaces had the maximum width of view 17.15 cm and 33.20 cm respectively. Also, from comparison with data from reference sensors, the maximum error and RMSE for orientation and position were 11.23°, 4.036° and 3 cm, 0.714 cm, respectively. Osadcuks et al. (2014) compared various sensors for application in mobile robotics in greenhouse environment. Ultrasound sensors were the most reliable for long-range obstacle detection in a greenhouse environment. Although the statistically significant influence of environmental conditions were observed, changes in maximum detection distances did not exceed 5 mm or 2.5% and there was no correlation with temperature and humidity. Also, short-range capacitive and inductive type sensors were not significantly affected by a greenhouse environment, however, the obstacle detection range of a capacitive decreased when moisture condensing occurred during temperature and humidity transients.

Although studies have been done on robot in the greenhouse, the study and evaluation of four-wheel robot have not reported yet in literatures for greenhouse spraying in Iran. The aim of this study was effective handling of human health challenges which somehow relates to working conditions in greenhouses. So, a four-wheel sprayer robot was designed for automatic spraying that had the ability of free movement between rows of plants. Navigation was evaluated based on acquired data from infrared sensors and the ultrasonic sensor was used to detect plants for spraying. Finally, the proposed sprayer robot was compared with traditional backpack sprayers. The effect of the speed (levels of 7, 14 and 21 m/min) on the spraying quality coefficient (Q_C) was investigated. Also, solution consumption, spray height, spraying time, and spray loss were calculated and compared in a greenhouse with bell pepper plants.

MATERIALS AND METHODS

1. Designing and Constructing the sprayer robot

Sprayer robot was designed and simulated using Autodesk inventor professional 2018 software (Fig. 1).

It was developed based on the following goals:

- Detection of the path drawn on the greenhouse floor by the infrared sensor.
- Detection of the plant by ultrasonic sensors installed on the sides of the robot.
- Send ultrasonic sensor signals to the control unit.
- Send command to sprayer unit operators by the control unit to start spraying operation.
- Stop spraying at the end of the crop row and follow the curved path at the end of the path, to enter the next row of greenhouses.
- Continue this operation until the end of the greenhouse.

So, the robot had three main parts including control and processing, drive and sprayer units. These parts were mounted on the chassis (Fig. 2).

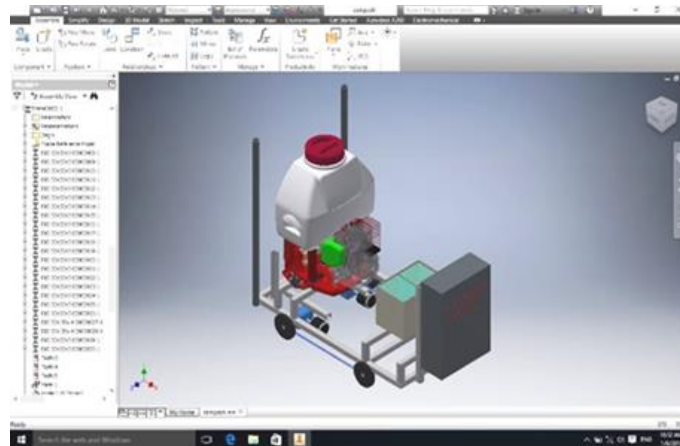

Fig.1 - The sprayer robot in the software environment

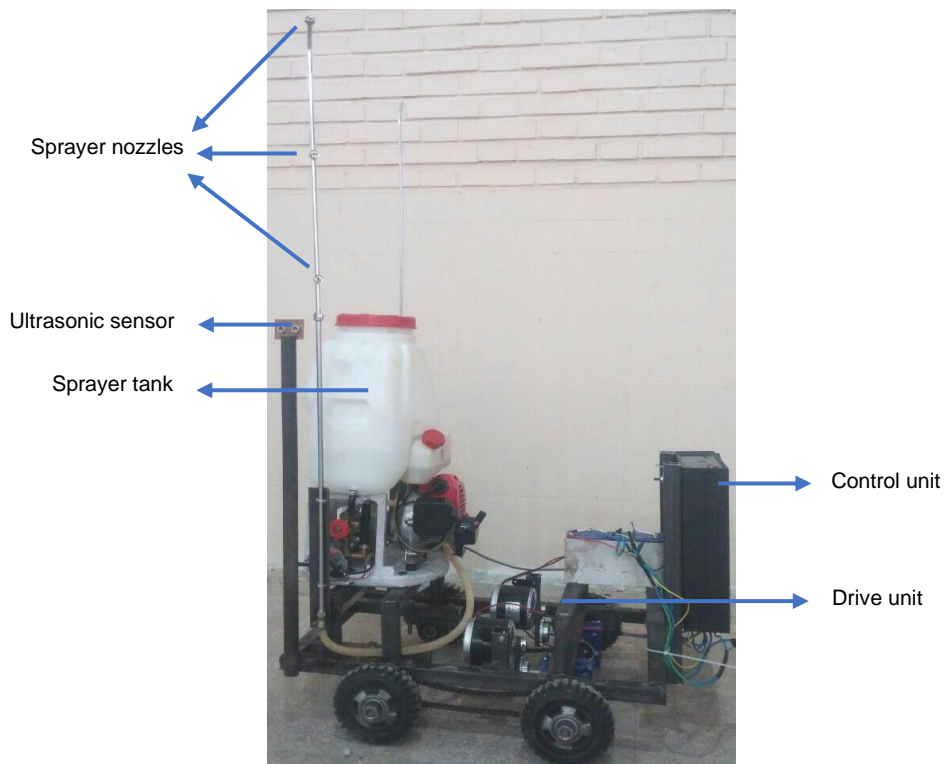

Fig. 2 - Different parts of the prototype robot

1.1 Control and processing unit

Fig. 3 and 4 show the control system implemented and various connections and units. The user interfaces had control over the running of the control unit (microcontroller) and were feedback data about the status of the robot. The control unit read the information and, after processing it, controlled the movements of the robot and the spraying system. The function of the microcontroller is any logical/calculation task that might be necessary for the spraying cycle. AVR microcontroller (ATmega-32 model) was used as the main control unit. Dynamic basic software was used as operational software. Microcontroller programming and circuit simulation were done in BASCOM-AVR 11 and PROTEUS 7 respectively.

The spraying system requires correct information as inputs, so the proper function of a robot (its controlling and spraying units) mostly depends on the efficiency of external sensors (Fig. 4). Therefore, a combination of infrared, ultrasonic and level sensors was installed. Another important subject was the effect of mechanical structural and other environmental factors, so analysis of advanced position was performed to find the best possible locations and encoder sensor was used. The LCD/Keypad module shows the user relevant

information on the status of the robot and allows the user to control the robot directly with ease. Further controlling operations were done through this module.

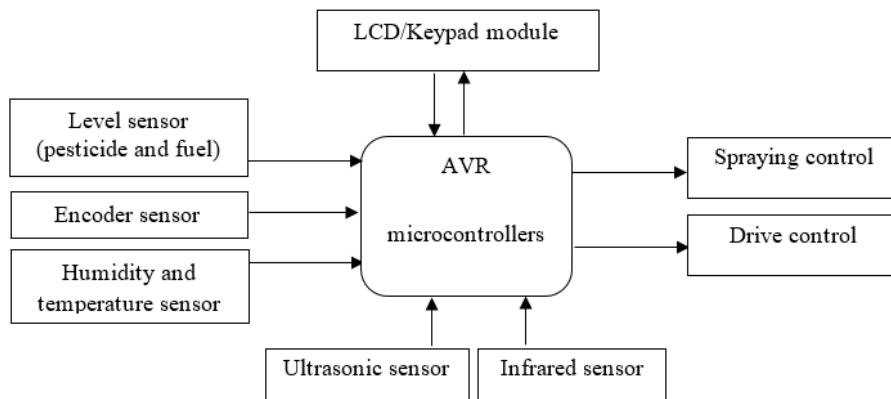

Fig. 3- Control system of the sprayer robot

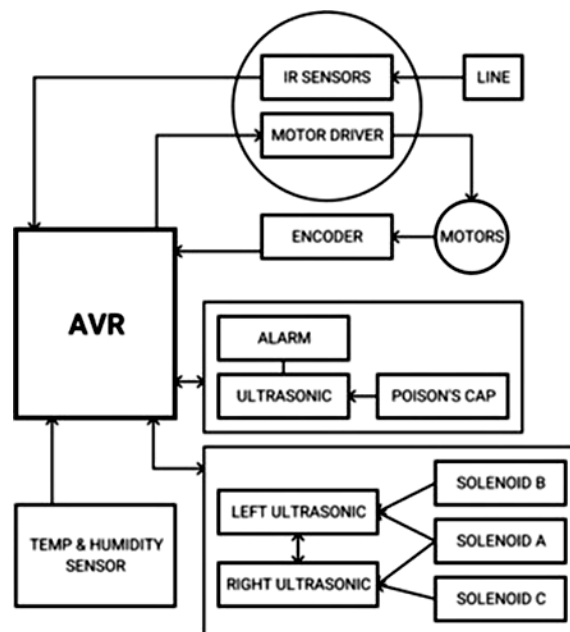

Fig. 4- Schematic of various connections and units

1.2 Drive unit

The robot was designed to be highly manoeuvrable in different directions. The cost was also considered as another factor. The drive unit consisted of a chassis, four wheels, a DC-type motor, a gearbox, and a belt and pulley. To select the engine, the moment of force for the wheel must be calculated to move the robot. So, the maximum weight of the robot, its centre of gravity and its distance from the wheels were calculated. Then, by considering the beam model with two simple supports and the concentrated forces applied to it, the free body diagram was drawn and the moment of force was calculated.

After the beginning of a movement, information about the location of the robot should be sent to the control unit, so the encoder sensor was used. Also, further adjustments were made by a user interface that controlled operational feedback. Lines in the greenhouse were marked to automatically guide the robot. The infrared sensor was used to navigate. It enabled the robot to track the lines between rows of plants.

1.3 Sprayer unit

The sprayer unit consisted of a 25-liter tank, a 1.7-liter/min centrifugal pump, a two-stroke engine (to operate the centrifugal pump), two vertical booms, three valves and three solenoids. Each boom had three nozzles. The distance of each nozzle was 25 cm from each other. The first nozzle had 90 cm high from the ground .

According to Fig. 5, the robot must perform the spraying operation according to its position in both one-way and two-way modes. The one-way spraying was related to the first and last rows of the greenhouse where

the cultivated plants were located on only one side of the robot. For this purpose, two solenoid control valves and ultrasonic sensors on the sides of the robot were used to determine the spraying state.

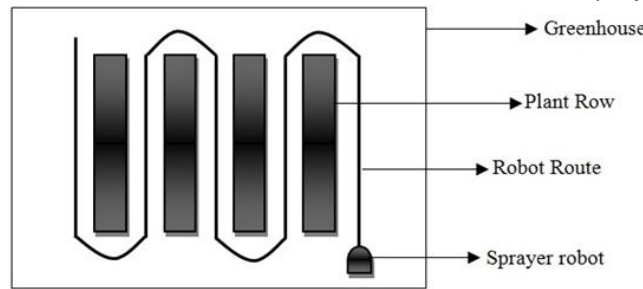

Fig. 5- The robot moving in the greenhouse

The SRF05 ultrasonic sensor with precision of 2 mm was used to detect the start and end of the plant row. An ultrasonic level sensor was used to control and measure the amount of solution in the tank. It alarmed the lack of solution as soon as the tank solution level reached a certain level. Also, this sensor measured the amount of solution consumed over a specified distance by measuring the height of the solution in the tank. Fig. 6 and 7 show the sprayer hydraulic circuit and schematic circuits of solenoids A, B and C, respectively.

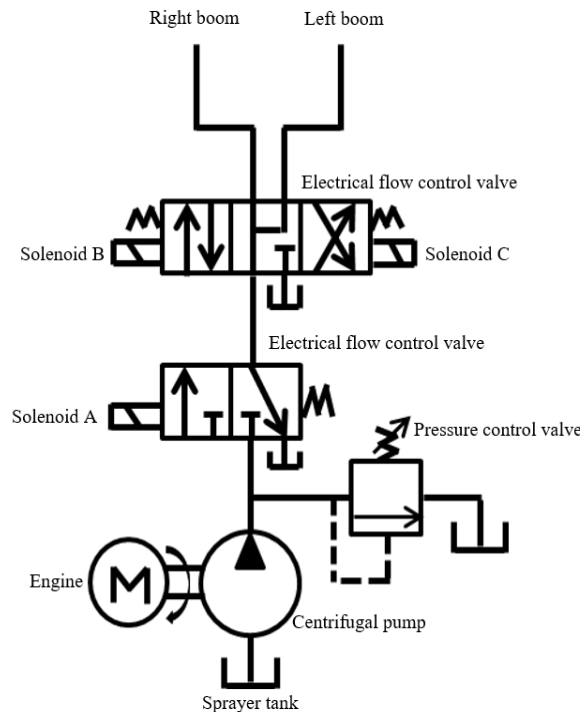

Fig. 6- Hydraulic circuit in sprayer unit

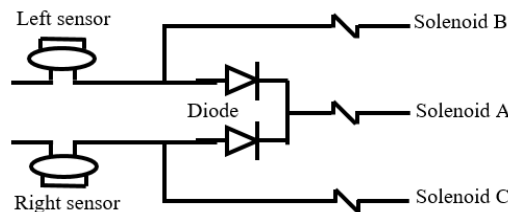

Fig. 7 - Schematic of the circuit of solenoids A, B and C

2. Evaluation of the sprayer robot

Sensors are not adjusted in the greenhouse environment, so in the first step, ultrasonic and infrared sensors were used in an initial experiment and calibrated by the experimental line follower robot (temperature=22°C, humidity = 67%). Another problem was the movement of the robot in the correct direction. Therefore unloaded chassis was tested separately from the controlling unit, and the movement angle was measured.

The sprayer robot was evaluated in a greenhouse in Dehaghan city of Isfahan province, with the specifications listed in Table 1.

Table 1

Characteristics of the greenhouse used for evaluating the sprayer robot

Product type	Area (m ²)	Corridor Length (m)	Width of corridors (cm)	Plant height (cm)	Temperature (°C)	Humidity (%)
Bell pepper	4500	40	90	250	22	67

Experiments were conducted to examine the effects of the speed (levels of 7, 14 and 21 m/min) on the spraying quality coefficient (Q_C) and also assessed solution consumption, spray height, spraying time, and spray loss in comparison with the conventional sprayer (the back sprayer/ TU26 /China). The experiments were performed in a completely randomized design with three replications. The data were analysed by SPSS and Excel software.

2.1 The optimal speed of the sprayer robot

To determine the optimal speed of the robot, spraying operations were performed in a 10 m path at three-speed levels of 7, 14 and 21 m/min in three replications. Then, the spraying quality coefficient (Q_C) was measured and evaluated using water-sensitive papers. The optimal speed was selected based on the best spraying quality.

Spraying quality was evaluated based on the standards of Institute of Standards and Industrial Research of Iran (Anon., 2008). The sensitive papers (dimensions: 3 x 7 cm) were placed at a distance of 50 and 25 cm in the direction of the sprayer movement and the plant height, respectively. Q_C was calculated based on Jafari Malekabadi et al., (2016). ACDSsee Pro 3 software was used to analyse the papers.

2.2 Spray Height

To evaluate spray height, sensitive papers placed on the plant were assessed. The papers of height 175 to 250 cm were collected and numbered. At each height, 10 papers were randomly selected and those that had been discoloured as a result of the droplets sitting were distinguished.

2.3 Spraying Time

A digital timer was set to measure time every 10 meters.

2.4 Spray Loss

The spray loss causes pollution of soil. The sensitive papers were placed under every plant according to Fig. 8. The papers were collected and the number and diameter of the droplets were measured in 1 cm². Then the area of the droplets was calculated. ACDSsee Pro 3 software was used to analyse the papers.



Fig. 8 - Position of sensitive cards to measure spray loss

2.5 Solution Consumption

After spraying, the amount of remained volume was measured, and then the sprayer tank was refilled for re-spraying. The solution consumption was also measured using the level sensor.

RESULTS

1. Evaluating the sprayer robot and determining the optimal speed

Investigation of ultrasonic sensor showed that the sprayer robot was capable for spraying plants on both sides of the greenhouse simultaneously, similar to the results obtained by *Cantelli et al. (2019)* and *Osadcuks et al. (2014)*. Evaluation of the robot's movement in the straight path showed that the 4 m displacement had a rightward deviation of 2.5 cm. Wheels were the main elements of movement, so front wheels were adjusted again. The new system had a deviation of 1.5 cm in the 4 meters and the sensors repeatedly corrected this deviation and did not increase cumulatively as the displacement continued. Therefore, the robot's guidance was done well by the infrared sensor.

Unlike some other research (for example *Sánchez-Hermosilla et al., 2013a*), this method did not require the installation of several sensors in the proximity of the corridor, especially at the end of the corridor, and accuracy was better than studies of *Younse and Burks, (2007)*. On the other hand, the sprayer robot used a simple system in this study. In contrast, in some studies, such as *Zhang et al. (2019)*, used a complex and expensive system.

The optimal speed was obtained based on the spraying quality coefficient, Q_C . The closer the coefficient is to 1, the better the quality. Fig. 9 shows the results of the evaluation of different speeds. The effect of speed was significant at 99% confidence level on Q_C . The speed of 14 m/min had better Q_C (2.56) and was the optimal speed. This result was similar to the results obtained by *Sammons et al. (2005)*.

At low speed, the Q_C was large and the quality decreased, because the leaves spray more time and the number of sprayed drops to the plant increases. So, the droplets cohere together and create a larger diameter. Also, when the speed of the robot exceeded the optimum value, the quality decreased. Because, the number of sprayed droplets to the plant decreases and, in the computation relation of the quality, with the decrease of the denominator of the fraction (the numeric median diameter), the Q_C becomes larger. Another reason could be that as the speed increased, the vibration rate of the sprayer boom increased.

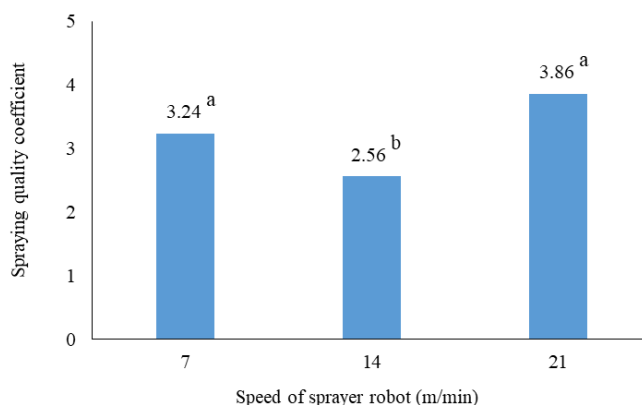

Fig. 9 - Spraying quality coefficient for different speeds
(The means with the same letter were not significant at 1% level)

2. Comparison of a robot with a conventional sprayer

In this section, experiments were performed at a robot speed of 14 m/min.

2.1 Spraying quality coefficient (Q_C)

Fig. 10 shows samples of the water sensitive papers for both types of sprayer. The results of the analysis of the papers showed that there was significant difference between the sprayers at 1% significance level on Q_C . The means of Q_C were 2.56 and 4.30 for sprayer robot and back sprayer, respectively (Table 2).

The nozzles of both types of sprayers were the same. The reason for the uniformity and better quality of the sprayer robot was: 1) the uniformity of movement and the constant speed of the robot, 2) unchanging the distance and displacement of the boom and its nozzles in the robot. In contrast, in the back sprayer, the operator speed was not the same and the boom distance from the plant varied. This result was similar to the results obtained by *Sammons et al. (2005)* and *Kalantari et al. (2014)*.

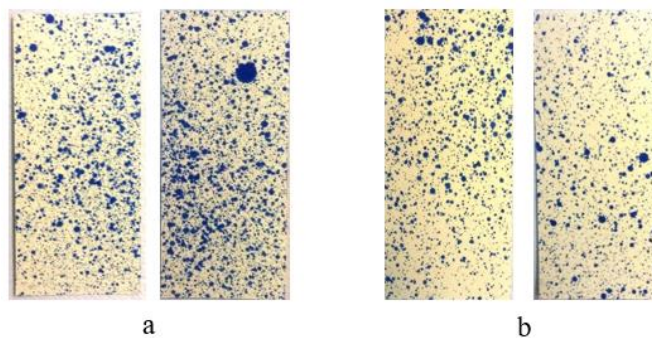

Fig. 10 - The water sensitive papers: a) back sprayer and b) sprayer robot

Table 2

Mean comparison of spray quality coefficient, solution consumption, spray height (number of wetted papers), spraying time and spray loss (area of droplets,) for sprayers

Parameters			Sprayer robot	Back sprayer
Spray quality coefficient			2.56 ^b	4.30 ^a
Solution consumption [litres]			5.26 ^a	4.06 ^b
Spray height [cm]	Height [cm]	175	10 ^a	9.67 ^a
		200	9.67 ^a	9.67 ^a
		225	6.67 ^b	9.67 ^a
		250	6 ^b	9.34 ^a
Spraying time [s]			22.66 ^b	68.26 ^a
Spray loss [mm ²]			5.57 ^b	7.31 ^a

Note: The means with the same letter were not significant.

2.2 Solution Consumption

The mean comparison of solution consumption demonstrated that the sprayer robot used approximately 30% less solution than the back sprayer, in a 10 m path. Some of the factors that caused to higher consumption by the back sprayer were the following: irregular and non-uniform movement of the operator, lack of skill and inaccuracies in spraying two-way modes, long working time and fatigue.

2.3 Spray Height

After spraying, the sensitive papers were collected at different heights (175, 200, 225 and 250 cm). The number of wetted papers was counted and their averages were compared. According to Table 2, there was no significant difference between the sprayers at the height of 175 and 200 cm. Therefore, the treatments were able to spray up to 2 m above ground level.

But there was a significant difference between the two sprayers at height 225 and 250 cm. Thus, the robot did not perform well in terms of spray height more than 2 m compared to the back sprayer. The reasons were the shortness of the sprayer robot boom and the low pressure of the sprayer pump. This problem will be resolved in further research and development of the robot for other activities and the results will be presented in the following articles.

2.4 Spraying Time

Analysis of spraying time results indicated that there was statistically significant difference at 1% level between different treatments. Comparison of means showed that the spraying time by the back sprayer was three times more than that of the sprayer robot (Table 2). So, the robot's performance was better than the conventional sprayer in terms of spraying time. The reasons were 1) the possibility of two-way spraying by the robot, 2) more robot nozzles than the back sprayer, and 3) operator fatigue and rest for the back sprayer.

2.5 Spray Loss

The area of droplets on the sensitive papers placed on the ground was calculated and there was significant difference between the sprayers (1% level). The means of spray loss area were obtained 5.57 and 7.31 mm for sprayer robot and back sprayer, respectively (Table 2). Therefore, the spray loss of the sprayer robot was less than that of the back sprayer and it had less soil contamination. On the other hand, the robot had better spraying quality coefficient Q_c . Thus, these two parameters had an inverse relationship. *Li et al. (2009)* and *Kalantari et al. (2014)* reported that the use of the robot would improve the uniformity of spraying and reduce drift and spray loss on the ground. The results of *Sánchez-Hermosilla et al. (2013b)* show that spraying at the high pressure (2000 kPa), the average deposit was between 22.5% and 34.6% less than at the lower pressures (1000 or 1500 kPa).

CONCLUSIONS

The main aim of this study was to investigate the potential of a four-wheel sprayer robot for spraying greenhouse with maximum efficiency, lower costs and simpler utilization. Navigation was evaluated based on acquired data from infrared sensors and the ultrasonic sensor was used to detect plants for spraying. Also, the proposed sprayer robot was compared with traditional backpack sprayers. The effect of the speed (levels of 7, 14 and 21 m/min) on the spraying quality coefficient (Q_C) was investigated. Solution consumption, spray height, spraying time, and spray loss were calculated and compared in a greenhouse with bell pepper plants in Iran. Although more study is needed, the results were promising and showed some benefits that can be achieved with robotic automation. From the obtained results, it can be concluded that:

- Sprayer robot had a rightward deviation of 1.5 cm in the 4 m displacement. Therefore, the robot's guidance was done well by the infrared sensor.
- Sprayer robot was capable for spraying plants on both sides of the greenhouse simultaneously with ultrasonic sensor, and its movement was uniform.
- The optimal speed was 14 m/min that had better spraying quality coefficient Q_C .
- The sprayer robot had better spraying quality than the back sprayer, while its solution consumption (30%) and spraying time (three times) were lower.
- The spray loss of the sprayer robot was less than that of the back sprayer and it had less soil contamination.
- The robot did not perform well in terms of spray height more than 2 m compared to the back sprayer. This problem will be resolved in further research.
- As a future work, the development of the sprayer robot can be using a hydraulic robot system to adjust the amount of spraying, toxin dose and the spray height. The camera or/and sensor can also be used to detect pests and spray only areas of the greenhouse that was infected by the pest.

REFERENCES

- [1] Anon, (2008). *Field measurement of spray distribution in tree and bush crops*. Institute of Standards and Industrial Research of Iran. No. 10347. www.isiri.org.
- [2] Bengochea-Guevara, J.M., Conesa-Muñoz, J., Andújar, D., Ribeiro, A. (2016). Merge fuzzy visual servo and GPS-based planning to obtain a proper navigation behaviour for a small crop-inspection robot. *Sensors*. 16 (3), 276. Doi: 10.3390/s16030276.
- [3] Cantelli, L., Bonaccorso, F., Longo, D., Melita, C.D., Schillaci, G., Muscato, G. (2019). A small versatile electrical robot for autonomous spraying in agriculture. *Agri Engineering*. 1: 391-402. Doi: 10.3390/agriengineering1030029.
- [4] Harik, E.H.C., Korsath, A. (2018). Combining hector SLAM and artificial potential field for autonomous navigation inside a greenhouse. *Robotics*, 7 (22).
- [5] Hernandez, A.C., Gomez, C., Crespo, J., Barber, R. (2016). Object detection applied to indoor environments for mobile robot navigation. *Sensors*. 16 (1180).
- [6] JafariMalekabadi, A., Khojastehpour, M. and Emadi, B. (2019). Disparity map computation of tree using stereo vision system and effects of canopy shapes and foliage density. *Computers and Electronics in Agriculture*. 156: 627-644. DOI: 10.1016/j.compag.2018.12.022.
- [7] JafariMalekabadi, A., Sadeghi, M. and ZakiDizaji, H. (2016). Comparing sprayer quality equipped with a telescopic boom with conventional sprayers in orchards in Iran. *Journal of Agricultural Science and Technology*. 18 (3): 585-599.
- [8] Kalantari, D., Shayanmehr, M., Refigh, A. (2014). Evaluation of the spray generated by a greenhouse spraying robot *Agricultural Engineering International: CIGR Journal*. 16 (1): 55-60.
- [9] Ko, M.H., Ryuh, B., Kim, K.S., Suprem, A., Mahalik, N. 2014. Autonomous greenhouse mobile robot driving strategies from system integration perspective: review and application, *IEEE*. 1705-1716. DOI: 10.1109/TMECH.2014.2350433.
- [10] Li, V., Xia, Ch., Lee, J. (2009). Vision-based pest detection and automatic spray of greenhouse plant. *International conference on (ISIE)*, Korea. Doi:10.1109/ISIE.2009.5218251.
- [11] Masoudi, H., Alimardani, R., Omid, M., Mohtasebi, S.S., Noguchi, N. (2012). Determination of ultrasonic sensor ability for use as guidance sensors of mobile robots. *Sensors and Materials*, 24 (3): 115–126.

- [12] Moreno, J., Clotet, E., Lupiañez, R., Tresanchez, M., Martínez, D., Pallejà, T., Casanovas, J., & Palacín, J. (2016). Design, implementation, and validation of the three-wheel holonomic motion system of the assistant, personal robot. *Sensors*. 16(10): 1658. DOI: 10.3390/s16101658.
- [13] Osadcuks, V., Pecka, A., Lojans, A., Kakitis, A. (2014). Experimental research of proximity sensors for application in mobile robotics in greenhouse environment. *Agronomy Research*, 12(3), 955–966.
- [14] Pahuja, R., Verma, H.K., Uddin, M. 2013. Wireless sensor network for greenhouse climate control, *IEEE*, 12 (2). DOI: 10.1109/MPRV.2013.26
- [15] Rincón, V.J., Grella, M., Marucco, P., Alcatrão, L., Sánchez-Hermosilla, J., Balsari, P. (2020). Spray performance assessment of a remote-controlled vehicle prototype for pesticide application in greenhouse tomato crops, *Science of the Total Environment*. Doi: 10.1016/j.scitotenv.2020.138509.
- [16] Rodríguez, F., Berenguel, M., Guzman, J.L., Ramírez-Arias, A. (2015). *Modeling and control of greenhouse crop growth*. Springer, London, UK.
- [17] Roldan, J.J., Garcia-aunon, P., Garzon, M., Leon, J., Cerro, J., Barrientos, A. (2016). Heterogeneous multi-robot system for mapping environmental variables of greenhouses. *Sensors*. 16 (7). Doi: 10.3390/s16071018.
- [18] Roldan, J.J., Joossen, G., Sanz, D., Cerro, J., Barrientos, A. (2015). Mini-UAE based sensory system for measuring environmental variables in greenhouses. *Sensors*. 15, 3334-3350.
- [19] Sammons, P.J., Tomonari, F. and Bulgin, A. (2005). Autonomous pesticide spraying robot for use in a greenhouse. *Australian conference on robotics and automation*, pp:1-9, ISBN 0-9587583-7-9, December, Sydney, Australia.
- [20] Sánchez-Hermosilla, J., González, R., Rodríguez, F., Donaire, J.G. (2013a). Mechatronic description of a laser auto-guided vehicle for greenhouse operations. *Sensors*. 13, 769-784.
- [21] Sánchez-Hermosilla, J., Paez, J., Rincon, V.J., Carvajal, F., (2013b). Evaluation of the effect of spray pressure in hand-held sprayers in a greenhouse tomato crop. *Crop Protection*. 54, 121-125. Doi.org/10.1016/j.cropro.2013.08.006
- [22] Sanz-Cortiella, R., Llorens-Calveras, J., Escolà, A., Arnó-Satorra, J., Ribes-Dasi, M., Masip-Vilalta, J., Camp, F., Gràcia-Aguilá, F., Solanelles-Batlle, F., Planas-DeMart, S., Pallejà-Cabré, T., Palacin-Roca, J., Gregorio-Lopez, E., Del-Moral-Martínez, I., Rosell-Polo, JR. (2011a). Innovative lidar 3D dynamic measurement system to estimate fruit-tree leaf area. *Sensors*. 11, 5769–5791.
- [23] Sanz-Cortiella, R., Llorens-Calveras, J., Rosell-Polo, JR., Gregorio-Lopez, E., Palacin-Roca, J. (2011b). Characterisation of the LMS200 laser beam under the influence of blockage surfaces. Influence on 3D scanning of tree orchards. *Sensors*. 11(3):2751–2772. doi: 10.3390/s110302751.
- [24] Sezen, B. (2003). Modeling automated guided vehicle systems in material handling. *Dogus University Journal*. 4(2), 207-216.
- [25] Sharma, S., Borse, R. (2016). Automatic agriculture spraying robot with smart decision making. *Intelligent Systems Technologies and Applications*. DOI: 10.1007/978-3-319-47952_1_60.
- [26] Subramanian, V., Burks, T.F., Singh, S. (2005). Autonomous greenhouse sprayer using machine vision and radar for steering control. *Applied engineering in agriculture*. 21, 935-943.
- [27] Younse, P. J., Burks, T. F. (2007). Greenhouse robot navigation using KLT feature tracking for visual odometry. *Agricultural engineering international: the CIGR Ejournal*. Manuscript ATOE 07 015. Vol. IX.
- [28] Zaman, S., Comba, L., Biglia, A., RicaudaAimonino, D., Barge, P., Gay, P., (2019). Cost-effective visual odometry system for vehicle motion control in agricultural environments. *Computers and Electronics in Agriculture*. 162, 82-94. Doi.org/10.1016/j.compag.2019.03.037
- [29] Zeng, S., Hu, H., Xu, L., Li, G. (2012). Nonlinear adaptive PID control for greenhouse environment based on RBF network. *Sensors*. 12, 5328-5348.
- [30] Zhang, T., Zhou, W., Meng, F., Li, Z. (2019). Efficiency analysis and improvement of an intelligent transportation system for the application in greenhouse. *Electronics*. 8, 946. Doi: 10.3390/electronics8090946.