

## ELABORATION OF DOSING METHOD FOR LIQUID BIOFUEL COMPONENTS

/

ELABORAREA METODEI DE DOZARE A COMPONENTELOR  
BIOCOMBUSTIBILILOR LICHIZICerempei V.<sup>1)</sup>, Molotcov Iu.<sup>2)</sup> 1<sup>1)</sup> State Agrarian University of Moldova; <sup>2)</sup> Institute of Agricultural Technics "Mecagro"Tel: (373) 796 777 28 E-mail: [cerempeivalerian@gmail.com](mailto:cerempeivalerian@gmail.com)DOI: <https://doi.org/10.35633/INMATEH-58-03>**Keywords:** liquid biofuel, components, dosage, continuing, installation, suction, pump

## ABSTRACT

There are presented the results of the bibliographical and theoretical research of the methods of liquid substances dosage. Based on the research were elaborated the method and continuing dosage installation of multicomponent mixtures to obtain liquid biofuel of high quality and minimum cost. In the proposed "Biomixt" installation the liquids flow is provided by the pressure reduction (suction) at the pump inlet. The theoretical analysis and experimental research of the installation allowed the justification of hydrodynamic parameters (cross-sectional area  $S$  of the pipes, pressure difference  $\Delta p$ , type of fluid flow  $Re > 10^4$ ), that provides the needed ratio of the components with the error  $\delta < 0.5\%$ .

## REZUMAT

Sunt prezentate rezultatele studiilor bibliografice și teoretice privind metode de dozare a substanțelor lichide. În baza acestor studii au fost elaborate metoda și instalația de dozare continuă multicomponentă, cu scopul de a obține biocombustibil lichid de înaltă calitate cu costul minim. În instalația propusă „Biomixt”, curgerea componentelor lichide este asigurată de căderea presiunii (aspirare) la intrare în pompa-malaxor. Analiza teoretică și cercetările experimentale ale instalației au permis argumentarea valorilor parametrilor hidrodinamici (aria secțiunilor transversale  $S$  ale conductelor, diferența de presiuni  $\Delta p$ , caracterul curgerii componentelor  $Re > 10^4$ ), care asigură raportul necesar al componentelor cu eroarea  $\delta < 0,5\%$ .

## INTRODUCTION

One of the most important operations of the biofuel production processes is the dosing and mixing of components, which must ensure the obtaining of quality and cheap mixed fuel with the precise ratio of component fractions (Gheorghisor M., 2003; Hăbășescu I., Cerempei V. et al., 2009). The study shows that the dosing of the fluid components is done by the discrete or continuous method. In the first case, the mixture is obtained in portions with the given volume or mass, discrete action dosimeters can be divided into the following groups: a) by level, b) by volume, c) by weight (Kurocikin A., 2006; Globin A., Krasnov I., 2012; Sârbu S., 2010).

*Dosing by level* is generally used to fill containers. The error of setting the  $h$  level of the liquid at the analysed dosimeters is quite small ( $< 0.5\%$ ), but when dosing the required volume of liquid, the accuracy of the measurement depends entirely on the properties and configuration of the exchange container, which suddenly limits the scope of this type of dosimeters.

The main difference in the case of volume dosimeters is their universality; they can be used in the most diverse technological processes provided that the geometric parameters of the working tank are stable. The dosing error of this type of dosimeters is the same as for level dosimeters (0.5%) and is generally determined by the accuracy of maintaining the given height  $h$ . However, it must be considered that in the first case it is ensured that only the given level is maintained, and in the second case the entire volume.

When dosing high viscosity liquids (concentrated oils, bitumen etc.), it is more efficient to use *gravity dosimeters*, which can be used both for dosing liquids and for forming doses of pulverulent materials.

The essence of the processes taking place in dosimeters can be explained with the help of operation cyclograms. For level dosimeters (Fig.1a), the time  $\tau_1$  for reaching the given level  $h_{max}$  in the container determines its productivity, which is equal to:

---

<sup>1</sup> Cerempei V., PhD. Habil. Eng.; Molotcov Iu, PhD.Eng.

$$Q_1 = f(dV/dS) = h_{\max} / \tau_1, \text{ [m/s]} \quad (1)$$

where  $dV/dS$  is the indicator that characterizes the change in the volume of the liquid when changing the section of the container filled by height.

The length of time,  $\tau_2$ , necessary to change the container, in general, is determined by the capacity of the dose. In turn,  $\tau_2$  influences the total duration of the dosimeter operation cycle  $\tau_\Sigma$ . In the case of filling the cylindrical container with diameter  $D$ , we obtain:

$$Q_1 = h_{\max} / \tau_1 = 4Q_p / \pi D^2, \text{ [m/s]} \quad (2)$$

where  $Q_p$  is the pumping flow of liquid in the container,  $\text{m}^3/\text{s}$ .

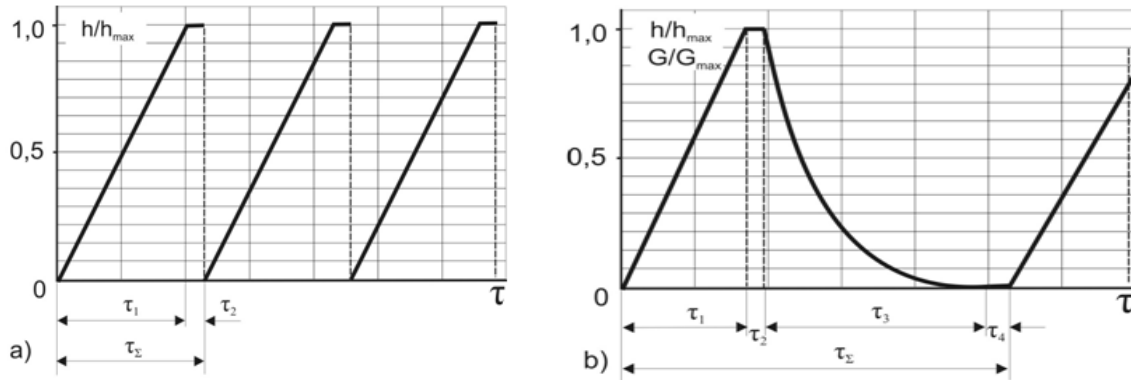

Fig. 1 - Operation cyclograms of discrete action dosimeters

a) dosing by level; b) dosing by volume and by weight

In the case of dosing by volume, the operation cycle of the dosimeter changes (Fig. 1b). As in the case of level dosimeter operation, the filling of the container with the dosed liquid takes place within the time interval  $\tau_1$ . At this stage the given volume  $V$  is formed, which for the working tank of arbitrary form is equal to:

$$V = \int_0^{h_{\max}} dS \cdot dh \text{ [m}^3\text{]} \quad (3)$$

Where:

$dS$  represents the area of the working tank section;

$dh$  – the height of the liquid in the tank.

For cylindrical tanks with diameter  $D$ , the volume of the dose will be equal to:

$$V = h_{\max} \pi D^2 / 4 \text{ [m}^3\text{]} \quad (4)$$

In the time interval  $\tau_2$ , the dosimeter switches from filling mode to dose removal mode. The size  $\tau_2$  depends on the operating speed of the dosimeter control system and on the operating elements inertia. Usually, the value  $\tau_2$  is much lower than  $\tau_1$ . The time  $\tau_3$  for the liquid draining from the working tank of arbitrary form, in general, is expressed by the formula (Nistoran D. et al., 2007; Gusev V., 2009):

$$\tau_3 = \frac{1}{\mu S \sqrt{2g}} \int_0^{h_{\max}} \frac{S_h dh}{\sqrt{h}} \text{ [s]} \quad (5)$$

Where:  $\mu$  is the flow coefficient;

$S$ – the area of the drain orifice section,  $\text{m}^2$ ;

$g$  – gravitational acceleration,  $\text{m/s}^2$ ;

$S_h$ – the area of the working tank section,  $\text{m}^2$ ;

$h$  – the current height of the liquid in the working tank,  $\text{m}$ .

When the area of the working tank cross-section is constant in height ( $S_h = \text{const}$ ), formula (5) gets the following form:

$$\tau_3 = \frac{2S_h \cdot h_{\max}}{\mu S \sqrt{2gh_{\max}}}, \text{ [s]} \quad (6)$$

In this mode, time  $\tau_3$  for full free draining of the liquid from the working tank is twice the draining time of the same volume  $V$  of liquid at the unchanged height  $h=h_{max}$ . The time interval  $\tau_4$ , also, as in the case of level dosimeter, serves to remove the metered dose and prepare the dosimeter for a new working cycle. The duration of  $\tau_4$  may vary within very wide limits depending on the specificity of production (Fig. 1b).

The operating cycle of the weight dosimeter is analogous to the one described above (Fig. 1b). The difference consists only in the fact that during its operation the height of the column  $h$  is not controlled, but the weight  $G$  of the dosed liquid or pulverulent material (flour, cereals, cement, etc.).

Thus, discrete action dosimeters ensure high dosing accuracy of components, but because of the successive execution of the technological phases (dosing, flow, packing change, electronic system resetting, etc.) they have a low specific productivity. Therefore, discrete action dosimeters have a broad application in technological processes, related to piece production, for example in the preparation of medicines and paints, in the packaging of beverages and oils.

In biofuel industrial production processes, it is now more effective to use continuous action dosimeters, in which continuous flows of the mixture ingredients are created with the flow rates determined, which are mixed during the motion to form a summary flow with the given component ratio. To ensure accurate dosing, these dosimeters require advanced technical means, including electronic command and control systems (ECCS). Flow dosing (continuous) has a greater perspective in biofuel production due to the high utilization rate of the machine and the virtually complete automation possibility of the main and auxiliary operations.

A *peristaltic (hose) pump* can be used in the continuous action dosimeter (Globin A., Krasnov I., 2012). Its operating principle is based on the elastic hose property of deforming and restoring its original shape several times. It is important that only the pump hose contacts the pumped liquid, which allows excluding the mutual contamination of the liquid and the pump.

Due to the high stability of peristaltic pumps productivity  $Q$ , they can be used in continuous technological processes with low and medium productivity, particularly in chemical and pharmaceutical production. Peristaltic pumps also have shortcomings, one of which is the pulsation of the flow at the pump outlet.

In continuous dosimeters, other types of pumps can also be used: centrifugal, rotor, piston diaphragm (membrane), gears (Kurocikin A., 2006; Globin A., Krasnov I., 2012; Diacek P., 2013). As follows, from the main characteristic  $Q=f(p)$  for the *centrifugal pump* (Fig. 2), at high pressure values the flow rate is suddenly reduced because of the liquid volume loss through the pump rotor. Therefore, centrifugal pumps are used to pump liquids with low viscosity at low pressure, with the possibility of adjusting the flow only by means of the control valves. These pumps are little used for dosing single-component liquids, especially in case of high requirements for dosing precision.

The *rotor pump* (Cercasskii V., 2005) differs from the centrifugal pump, first of all, by the displacement method of the fixed volume of liquid, which is formed by the complete rotation of each arc segment of the rotor. However, as in the case of the centrifugal pump, in the rotor pump, liquid loss between the pump segments and its housing (at higher pressure values) may occur, which results in a reduction of the flow (Fig.2). Rotor pumps are also little used as continuous dosing devices.

In the *piston pump (plunger)* the working part is the piston, which performs rectilinear-alternative movements. There are pumps with a piston and with several pistons (Globin A., Krasnov I. 2012). One of the disadvantages of piston pumps, like other volume pumps, is the pulsation of the liquid pressure at the pump outlet. Pulsation can be reduced by placing a few pistons in a row and joining them with a shaft so that their working cycles are offset from each other after the phase at equal angles. Another method of decreasing pulsation is to use a differential scheme for pump connection in which the pumping of the liquid is effected not only during the stroke of the piston but also during the return movement. For double action pumps, the pulsation rate is lower and the yield is higher than for simple action pumps. In order to reduce the pulsation, hydro-accumulators are used, which at the moment of maximum pressure accumulate energy, and at the moment of pressure drop they release it.

The productivity of the piston dosing pumps is adjusted to a relatively small extent by changing the displacement of the piston and the speeds of the electric motor. Pumps of this type have a relatively low productivity (hundreds of litres per hour) at the pressure of hundreds of bars. The direct contact of the mobile metal parts with the dosed liquids is another drawback of the piston pumps. This drawback can be partially removed by using an intermediate separation diaphragm or silphon. Only the diaphragm gets in contact with

the liquid transported and it can be made of a material resistant to the given environment, for example Teflon. This type of pump is called *diaphragm and piston pump* (Bařta T. et al., 2010).

In diaphragm dosing pumps, the absorption and discharge of liquid in the working chamber of the dosing head is due to forced oscillation of the diaphragm, which is one of the walls of the chamber. As with piston dosing pumps, the diaphragm pump working chamber is equipped with suction and discharge valves.

Adjustment of the dosing volume to these types of pumps is effected by changing the amplitude and frequency of the piston rod movement. It should be noted that due to the similarity of the operating principles, the piston and diaphragm pumps have analogous characteristics  $Q=f(p)$  (Fig.2).

Lately, a wide spread has been achieved by *multi-channel dosing pumps (multi-stage)*, in the case of which several dosing heads are operated from an electric motor; they can be piston pumps or diaphragm pumps. The dose of each channel can be further adjusted by means of flow control devices (Globin A., Krasnov I., 2012; <https://www.hydra-cell>). Multichannel dosing pumps can provide a higher accuracy in maintaining the flow rate of the dosed liquids, have lower specific material consumption and cost compared to piston or diaphragm pumps with one channel in the case of concomitant dosing of several components. However, all the mentioned pumps have the same operating principle and, therefore, similar advantages and disadvantages.

Petroleum, food and chemical industries have become the application field of *gear dosing pumps*. The main advantage of this type of dosing pumps is the possibility to pump liquids with high temperature and viscosity. Their disadvantage is the direct contact of the liquid dosed with the pump construction elements. For the preparation of mixed biofuels, it is not required to pump the components of the mixture at high temperatures and pressures, so it is not appropriate to use gear pumps for this purpose.

For continuous dosing and mixing of some liquids, Venturi tube dosimeters are used (Globin A., Krasnov I., 2012). At the basis of the operation principle of this type of dosimeters is the ejection or jet effect, which consists in reducing the pressure in the fluid flow in a narrow sector of the pipe. The dosimeter (Fig. 3) consists of the nipple 1 for supplying the main liquid (ejectable) to the Venturi tube, the inner section of which is narrowly made, nipple 2 for supplying the ejected liquid ending in the narrowing zone and the diffuser 3. The ratio of the mixture components at Venturi tube outlet is characterized by the ejection coefficient:

$$u = Q_2 / Q_1 \quad (7)$$

where  $Q_1$ ,  $Q_2$  represents the flow of the basic liquid and of the ejectable one, respectively, m<sup>3</sup>/s.

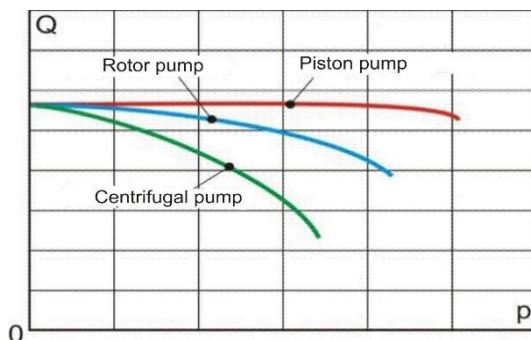

**Fig. 2 - Liquid flow according to pressure for different types of pumps**

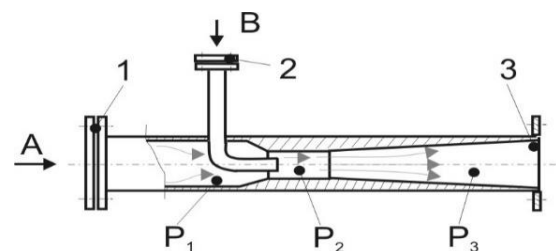

**Fig. 3 - Device for continuous dosing and mixing of two liquids with a Venturi tube ( $p_2 < p_1$ ):**  
1,2- nipple; 3- diffuser

The method of continuous dosing with ejection has low stability in maintaining  $Q_1/Q_2$  ratio and low yield (<35%). Therefore, the specific energy consumption in the preparation of the fuel mixture by this method is quite high (up to 0.8 kWh/m<sup>3</sup>). In these installations, it is virtually impossible to directly control and adjust the productivity of the nozzles for supplying auxiliaries and additives.

Therefore, the existing bibliographic sources describe mostly single-component liquid-dosing methods and installations, while liquid biofuels contain several components (monohydric alcohols and petrol, biodiesel and diesel, etc.). At the same time, multicomponent dosing installations with multichannel dosimeters (piston or diaphragm, Venturi tube) have emerged lately, but these do not meet all the requirements of the technological process of liquid biofuel production.

Therefore, it is necessary to perform a complex of activities for the elaboration of the method and the installations that ensure the continuous and simultaneous metering of several components, strictly observing the ratio between them and with a minimum cost for the mixture production.

## MATERIALS AND METHODS

After conducting bibliographic studies, we proposed technical solutions directed towards a greater efficiency of the biofuel production process, which requires carrying out the theoretical and experimental researches to achieve the stipulated goal. Therefore, the following activities were carried out:

1. Conceiving, developing the installation for dosing and mixing liquid biofuels components. Verifying the compliance of pilot installation functional parameters submitted for tests with those set out in the design phase;

2. Performing the theoretical analysis of hydrodynamic parameters, which influence the flow of liquid in the installation pipes;

3. Determining the dependence of the mixture flow rate on the hydraulic strength of the exhaust channel. Estimating possible dosing errors, resulting from the theoretical calculation, and comparing them with the actual ones. Testing the process of adjusting the ratio between the components of the fuel mixture.

In order to achieve the stipulated goal, the method and the installation "Biomixt" were developed for preparing combustible mixtures (Hăbășescu I., Cerempei V. et al., 2009; Hăbășescu I. et al., 2011). In the developed installation, dosing-mixing of components is achieved at the pump inlet, due to the phenomenon of suction (absorption) of the components through pipes with adjustable hydraulic resistance (Fig. 4). Initial components are dispensed through two pipes, distributors 1, filters 2, flow transducers 3 in a mixing pump (multi stage) 5. A metering unit 6 is mounted in the supply pipe of the lower fraction component (e.g., alcohol) and at the outlet of the mixing pump - the manometer 7 and the adjustable choke valve 8, which regulates the flow of the mixture obtained, and through which it is pumped into the storage tank. Installation drive and component ratio monitoring are performed using the command and control unit 4.

The basic assembly of the installation is the mixing pump 5, which aspirates and mixes the components, ensuring a biofuel with elevated phase stability. The component dosing is based on the dependence of the liquid flow, in the case of constant pressure, on the cross section of the pipe  $Q = f(S)$ . In the "Biomixt" installation, the supply pipe of the larger fraction (e.g. petrol) is not equipped with regulating devices, and the small fraction component pipe has the metering unit 6 (Fig. 4). With this metering unit, the ratio between the pipe sections and the ratio of the mixture components can be changed. After adjusting and checking, the hydrodynamic parameters remain constant, therefore a continuous stable flow of components is formed with the required flow rates  $Q_1$  and  $Q_2$ .

In general, the installation of devices that increase the local hydraulic resistance at the inlet to the centrifugal pump results in an increased pressure reduction in the pump working chamber and the occurrence of the cavitation effect (Nistoran D. et al., 2007; Diacek P., 2013). The proposed dosing system assures the simultaneous absorption of the components through two (or more) pipes, of which the larger diameter pipe has the constant section. Therefore, at the partial closure of the small diameter pipe, the flows ratio changes, not affecting the normal operating conditions of the pump.

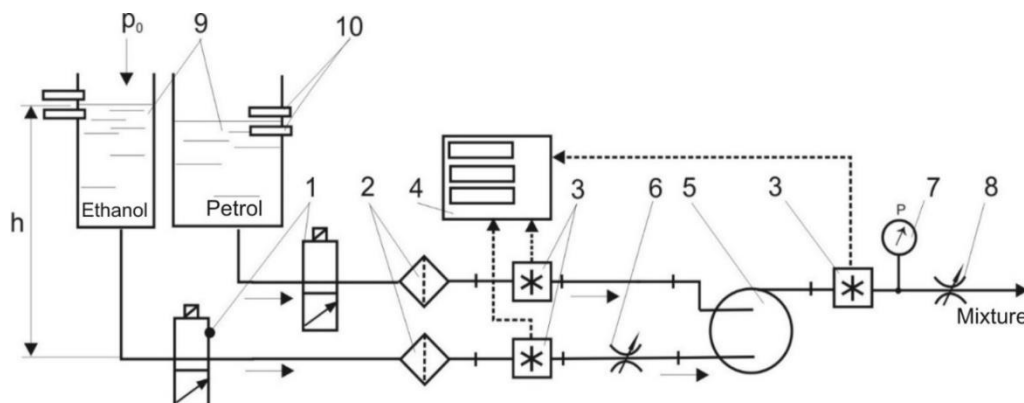

**Fig. 4 - Hydraulic block scheme of "Biomixt" installation**

1 – hydraulic distributors; 2 – filters; 3 – flow transducers; 4 – drive block; 5 – mixing pump; 6 – metering unit (adjustable choke valve); 7 – manometer; 8 – adjustable choke valve

Electronic flowmetres allow metering of momentary and integral flows of mixed components and of the finished product. Recorded flowmeter information can be used to organize the operation of the installation electronic system ECCS. The homogenization of the mixture composition is carried out in the pump working chamber by using several pumping steps. The number of mixture components can be increased by increasing the number of absorption pipes at the mixing pump. The component B feed pipe metering unit for each experiment is positioned so as to provide the following volumetric ratios of the mixture constituents:  $Q_B/Q_A = 10/90; 20/80; 30/70; 40/60; 50/50$ .

The veracity of the flow rate measurement in each pipe was ensured by using the adjusted flowmetres, checked, and by repeating the measurements 10 times. Based on the research results, the average flow rate was determined:

$$Q_m = \sum_{i=1}^n Q_i / n, [m^3/s] \quad (8)$$

where  $Q_i$  is the result of flow measurement  $i$ ,  $m^3/s$ ;

$n$  – number of experiments performed.

The deviation  $\Delta_i$  for each measurement  $Q_i$  from  $Q_m$  was then calculated, taking into account the sign, and the relative dosing error for each measured flow rate was determined:

$$\delta_i = (\Delta_i / Q_m) \cdot 100 \% \quad (9)$$

The established flow rate reproducibility assessment is performed by repeating one of the described experiments for 16 hours without changing the position of the control valve. In this case, for each series of experiments,  $Q_m$  is calculated, the average of which is compared to the overall average value.

The *analysis of hydrodynamic parameters*, which influence the flow of liquid in the elaborated installations, demonstrates that their operation is based on leakage of the liquid through an orifice or through a calibrated pipe (supply pipe) under overpressure. For the above-mentioned conditions, the determination of the flow rate  $Q$  is performed based on the formula (Nistoran D. et al., 2007; Bašta T., 2010):

$$Q = SV = S\mu\sqrt{2gH}, [m^3/s] \quad (10)$$

where  $S$  is the actual area of the orifice section through which flow occurs,  $m^2$ ;

$V$  – the actual flow velocity of the liquid,  $m/s$ ;

$\mu$  - the flow coefficient, which takes into account the shape of the orifice, the state of the orifice edges, the degree of jet compression and the flow character ( $Re$ );

$g$  – gravitational acceleration,  $m/s^2$ ;

$H$  – the total (calculated) flow rate,  $m$ , which can be determined with the following relation:

$$H = h + \frac{(p_1 - p_0)}{\rho g} = h + \frac{\Delta p}{\rho g}, [m] \quad (11)$$

where:  $h$  is the height of the liquid column at the inlet of the supply pipe,  $m$ ;

$p_1, p_0$  – pressure, respectively at the inlet and outlet of the supply pipe ( $p_1 > p_0$ ),  $Pa$ ;

$\rho$  - dosed liquid density,  $kg/m^3$ .

The flow coefficient  $\mu$  influences the flow rate  $Q$  and represents the multiplication of the jet compression coefficient  $\varepsilon$  by the velocity coefficient  $\varphi$ . The coefficient  $\varphi$  characterizes the influence of the local hydraulic resistances on the fluid flow rate, and the coefficient  $\varepsilon$  - the change of the jet geometry in relation to the outlet section. The values of all coefficients depend on the Reynolds criterion, which describes the character of the dosed liquid movement:

$$Re = \frac{dV}{\nu} = \frac{d\mu\sqrt{2gH}}{\nu} \quad (12)$$

where  $d$  is the characteristic diameter of the flow pipe,  $m$ ;

$V$  - the flow rate of the ideal liquid under the action of the total pressure  $H$ ,  $m/s$ ;

$\nu$  - the kinematic viscosity of the dosed liquid,  $s/m^2$ .

Equation (12) is valid for relatively small orifices where the local velocities of liquid at all points of the compressed section are virtually equal, which is observed at  $d \leq 0,1H$  (Gusev V., 2009).

The calculations show (Fig. 5) that with the increase of the flow velocity  $V$  and hence with the increase of the  $Re$ , the velocity coefficient  $\varphi$  suddenly increases and tends to the value  $\varphi=1.0$  (Gusev V., 2009). This fact testifies to the significant decrease in viscosity influence on the flow process. In the range of very low flow rates ( $Re<25$ ), the viscosity role is high. However, such flow regimes are rarely used (precision dosing in research laboratories) and, as a rule, only present theoretical interest.

By increasing the criterion  $Re$ , the coefficient  $\varphi$  increases as the coefficient of resistance  $\gamma$  decreases and the jet compression coefficient  $\varepsilon$  decreases and tends to the value  $\varepsilon=0.6$ . At the same time, the flow coefficient  $\mu$ , which is the multiplication of the coefficient  $\varphi$  by  $\varepsilon$ , increases during the first stage, reaching the maximum value ( $\mu=0.69$  for  $Re\approx 350$ ), then decreases slowly to  $\mu=0.6$  and changes a little with the subsequent increase of the  $Re$  criterion. Therefore, because of the coefficient  $\mu$ , the actual value of flow rate  $Q$  is reduced by 30-40% relative to the flow, calculated for the ideal liquid.

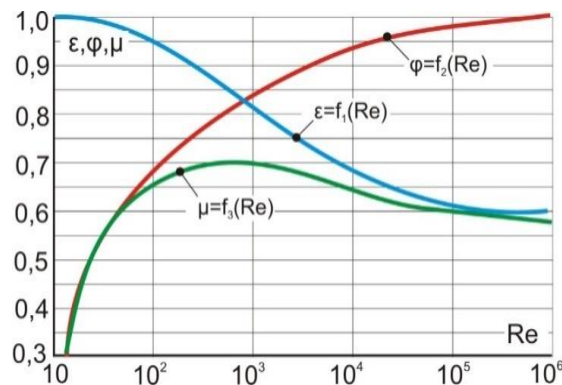

Fig. 5 - Flow coefficients based on the value of the Reynolds criterion ( $Re$ ) for the ideal liquid flow

A special interest in practice is represented by the sector in the graph  $\mu=f(Re)$ , where the changes in the size  $\mu$  are insignificant relative to  $Re$ , namely for  $Re>10^4$  (turbulent flow regime). In this case, the  $Q$  value will depend only on the  $S$ -section (at constant values of the difference  $p_1-p_0$  and the height  $h$ ), which reduces the dosing error, excluding one of its sources - the dependence of the flow coefficient  $\mu$  on the liquid flow character ( $Re$ ).

The value of the total flow pressure  $H$  (formula 11) and hence the flow  $Q$  (formula 10) is influenced by liquid column height  $h$ . Practically, the value  $h$  can be maintained with a certain accuracy within the limits  $\pm\Delta h$ . Thus  $h$ , at any moment, will be in the range  $h\pm\Delta h$ .

The dosing error, which is present in all cases, can be expressed (Cerempei V., 2016):

$$\delta = \frac{Q - Q_r}{Q} \cdot 100\% = \left[ 1 - \sqrt{1 + \frac{\Delta h}{h + \frac{\Delta p}{\rho g}}} \right] \cdot 100\% \quad (13)$$

where  $Q$  and  $Q_r$  represent the flow rates, respectively, the nominal and the real flows (for constant  $S$  and  $\mu$ ),  $m^3/s$ .

Therefore, virtually the dosing error of each component and of the ratio between the components in the fuel mixture depends on the accuracy of maintaining the liquid column height ( $\Delta h$ ) and the pressure difference  $\Delta p$  at the inlet and outlet of the dosing system as well as on the height  $h$ .

## RESULTS

It follows from formula (13) that the dosing error  $\delta$  can be reduced by increasing the height  $h$  and overpressure  $\Delta p$ , keeping the height drop  $\Delta h$  at minimum values. However, for the dosing scheme developed (Fig. 4) the possibilities of increasing the pressure drop  $\Delta p$  are limited because of the centrifugal pump characteristics (Fig. 6). It follows from the above that for the given case the decrease of  $\delta$  can be done, as far as possible, by increasing the height  $h$  and by using perfect methods of maintaining the value  $h$  ( $\Delta h \rightarrow \min$ ).

In the preparation of liquid biofuels, it is extremely important to keep the ratio of the components constant ( $Q_1:Q_2:Q_3: \dots :Q_i = \text{constant}$ ). Ensuring the accuracy of this ratio is directly influenced by the correctness of choosing the diameters of the supply pipes of the respective components to the pump nipples.

In the first stage of the experimental researches in the "Biomixt" installation, both above-mentioned pipes with a conventional diameter of 20 mm were used. Research has shown that the ratio of the mixture components, at the same position of the metering unit 6 (Fig. 4) changes considerably when the pressure is equal to 0.35-0.45 MPa (Fig. 6) at the outlet of the mixing pump. It has been demonstrated that in this pressure range there are "critical" points when the character of liquids movement in pipes changes as follows: for the "Ethanol" channel - from laminar to intermediate and in the "Patrol" channel - from the intermediate regime to the turbulent one. At the same time, it was found that the presence of these "critical" points caused lower dosing accuracy and poor flowmeter functioning.

As mentioned, the hydraulic resistance in pipes depends to a great extent on the liquid flow regime, and is a function of the Reynolds criterion. The theoretical analysis allowed us to determine the value of this criterion ( $Re > 10^4$ , Fig. 5) and then we determined the optimal diameters of the pipes, which ensure that the required ratio of the mixture components is maintained.

In the world practice, the ethanol fraction in most cases varies between 5-20% vol. mixed with petrol (95-80% vol., respectively). In some countries (e.g. Sweden), E85 blend is used with the ethanol fraction of 85% vol. It should be mentioned that in the "Biomixt" installation, the minimum flow of each component can be at least 0.5 m<sup>3</sup>/h. This flow represents the lower limit that ensures a practically stable operation of all flowmetres used (including those developed at IAT "Mecagro"). It is important to specify that in the case of E20 the minimum flow of petrol is four times higher than that of ethanol:

$$Q_{\text{ethanol}}^{\text{min}} = 0,5 \text{ m}^3/\text{h}; \quad Q_{\text{benz}}^{\text{min}} = 2.0 \text{ m}^3/\text{h}; \quad Q_{\text{amest}}^{\text{min}} = 2.5 \text{ m}^3/\text{h}.$$

In turn, the maximum flows are determined by the pump characteristic (Fig. 6).

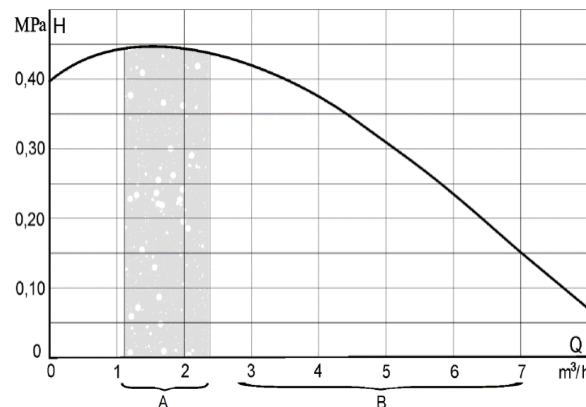

**Fig. 6 - Mixing pump characteristic**

A – the area of unstable flow regimes of components;

B – the area of turbulent (with stable ratios) flow regimes of components

Based on formulas (12) and (10), we get the value of the criterion for each component:

$$Re_i = \frac{4 \cdot Q_i}{\pi \cdot d_i \cdot v_i} \quad (14)$$

from where can be deduced the relation for calculating the "critical" diameters of the pipes:

$$d_i = \frac{4Q_i}{Re_i \pi v_i} \quad (15)$$

In the range of extreme flows ( $Q_{\text{amest}}=2.5 \dots 8 \text{ m}^3/\text{h}$ ) in the "Biomixt" installation it is necessary to use pipes with diameters that ensure a turbulent flow of liquid. Pipe diameters have been determined, taking into account the basic principle of hydraulic stability, which confirms that the ratio between the liquid flow rates  $Q_{\text{real}}$  and  $Q_{\text{max}}$  for a particular system should tend to 1. The closer this ratio is to 1, the safer the stability of the hydraulic regime.

Applying the principle of hydraulic stability to the "Biomixt" installation, it follows that the ratio of the cross-sectional areas of the pipes through which biofuel components flow (e.g. petrol and ethanol) should be close to the flow ratio of these liquids, namely  $S_{\text{ethanol}} \cdot S_{\text{benz}} \approx Q_{\text{ethanol}} \cdot Q_{\text{benz}}$ .



Starting from these requirements and the effective ratio of components:  $Q_{\text{ethanol}}:Q_{\text{benz}}=1:4$ , are calculated based on formula (15) and the following pipe diameters are used: a) for 1/4" ethanol (conventional flow diameter  $d_c=10$  mm); b) For 3/4" petrol ( $d_c=20$  mm).

After improving the construction, the "Biomixt" installation (fig. 7) was subjected to the second stage research, which proved the beneficial character of the modifications. The pump characteristic practically didn't change (Fig. 6), but the actual working range was enlarged: the pressure of the fuel mixture at the pump output - 0.07 ... 0.43 MPa and the flow rate  $Q=2.5...8$  m<sup>3</sup>/h. In this range, the turbulent flow stability of the components in the respective pipes is ensured, as well as the minimum dosing error of components ( $\delta<0.5\%$ ). The long-term tests ( $\tau=16$  h) showed a high degree of reliability in the operation of "Biomixt" installation.

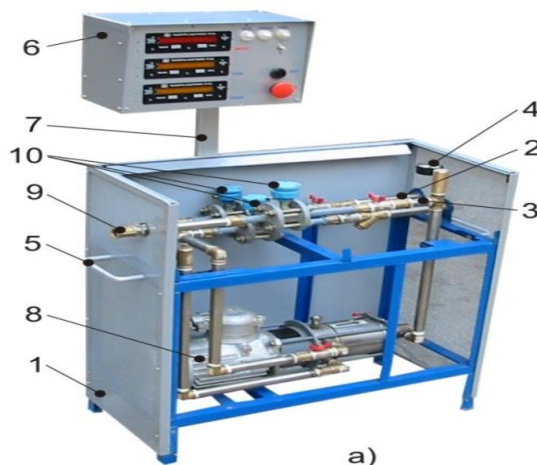

Fig. 7 - "Biomixt" installation (general view) (Hăbășescu et al., 2011)

1 - frame; 2,3- supply pipes; 4- manometer; 5-handles; 6- drive block; 7- support; 8- pump; 9- exhaust pipe; 10- flow transducers

## CONCLUSIONS

1. The analysis of the dosing methods shows that the biggest perspective for the preparation of liquid biofuels is by continuous method, which has a relatively high productivity and low specific production costs. Continuous dosing requires advanced ECCS electronic systems to ensure the required quality of mixed fuels and sustainable operation. In liquid continuous mono-component dosing methods is used a wide range of devices provided with different pumps (peristaltic, piston, diaphragm, diaphragm and piston), which provide a relatively high dosing accuracy, but, at the displacement of the liquid therein pressure pulsations are inevitable, which negatively affect the normal operation of the ECCS.

2. For fuel mixtures, it is important to maintain within the established limits the quantitative ratio of the components ( $Q_1:Q_2:Q_3...:Q_i = const.$ ) and not the quantity of each of them ( $Q_1, Q_2, Q_3, ..., Q_i \neq const.$ ). The use of autonomous pumps for dosing each component will inevitably lead to larger errors in the composition of the mixture, since each pump has specific errors itself. Existing (piston, piston-diaphragm) multi-channel (multi stage) installations provide the required dosing accuracy, but pressure pulsations are present therein and productivity is limited.

3. The analysis of the hydrodynamic parameters showed that for concrete conditions, the flow rate  $Q$  depends not only on the surface of the pipe cross section  $S$ , the overpressure  $\Delta p$  along the pipe, but also on the liquid flow character, namely  $Q=f(S, \Delta p, Re)$ . It was theoretically and experimentally demonstrated that the transport of liquid through calibrated pipes is stable, and the dosing error  $\delta$  is minimal ( $\delta<0.5\%$ ) when  $Re>10^4$ . We identified the advantages of dosimeters operating principle based on the absorption of the components through separate pipes with adjustable hydraulic resistance and dosing-mixing of components in the flow. Based on these achievements, the "Biomixt" installation was developed, which is distinguished by the wide-limit working range (the fuel mixture pressure at the pump outlet 0.43-0.07 MPa, respectively the flow  $Q=2.5-8$  m<sup>3</sup>/h), multi-component dosing error  $\delta<0.5\%$ , higher reliability, increased constructive simplicity compared to existing ones on the market.

## REFERENCES

- [1] Bașta T.M., Rudnev S.S., Necrasov B.B. et al., (2010), *Hydraulics, machines and hydraulic drives (Гидравлика, гидромашини и гидроприводы)*. Alians publishing House, Moscow/Russia, 423 p.;
- [2] Cercasskii V.M., (2005), *Pumps, fans, compressors (Насосы, вентиляторы, компрессоры)*. Energie Publishing House, Moscow/Russia, 416 p.;
- [3] Cerempei V., (2016), *Technology and technical means of production and use of biofuels based on monohydric alcohols*, Habilitation thesis, State Agrarian University of Moldova, Chișinău / Republic of Moldova, 428 p.;
- [4] Diacek P.I., (2013), *Pumps, fans, compressors (Насосы, вентиляторы, компрессоры)*. ASV Publishing House, Moscow/Russia, 432p. ISBN 978-5-93093-784-8;
- [5] Gheorghisor M., (2003), *Fuels, lubricants and special car materials*. Paralela Publishing House, Bucharest/Romania, 323 p.;
- [6] Globin A.N., Krasnov I.N., (2012), *Dosimeters (Дозаторы)*. FGBOU VPO ACGAA Publishing House, Zernograd, Rostov/Russia, 348 p. ISBN 978-5-91833-073-9;
- [7] Gusev V.P., (2009), *Basics of Hydraulics (Основы гидравлики)*. Tomsk Polytechnic University, Tomsk/Russia, 172 p. ISBN 978-5-93693-075-8;
- [8] Hăbășescu I., Cerempei V. et al., (2009), *Biomass energy: technologies and technical means*, Bons Offices Publishing House, Chișinău / Republic of Moldova, 368 p., ISBN 978-9975-80-301-4;
- [9] Hăbășescu I., Cerempei V., Molotcov Iu., (2011), *Device for dosing and mixing liquids*. Patent, no.363Y, Republic of Moldova;
- [10] Kurocikin A.A., (2006), *The basics of calculating and designing machinery and apparatus in the processing industry (Основы расчета и проектирования машин и аппаратов перерабатывающей промышленности)*. Kolos Publishing House, Moscow, 320p.;
- [11] Nistoran D.E., Moatăr Fl., Manoliu M., Ionescu Gr., (2007), *Technical Hydraulics*. Printech Publishing House, Bucharest/ Romania, 226p. ISBN 978-973-718-661-4;
- [12] Sârbu S., (2010), *Theoretical and experimental research on the optimization of the gravimetric dosing processes of agro-food solids*. PhD thesis abstract, Transilvania University of Brașov, Brașov / Romania, 59 p.;
- [13] \*\*\**Use of Hydra Cell pumps as dosing pumps* - <https://www.hydra-cell.co.uk/ro/?pgid=343>